

TD 218 OPERATING MANUAL

OXYGEN OPTODE 3830, 3835

3930, 3975, 4130, 4175



1 st Edition – 9 th Edition		2002 - 2003	
10 th Edition	June	2004	Full revision
11 th Edition	23 December	2004	Minor corrections/additions and
	p. 5		new page Important
	p. 30		Chapter 4 revised
	p. 49		Appendix 6 revised
	p. 54		new Appendix 8
	p. 58		new drawing
	p. 60		Appendix 10 revised
12 th Edition	16 August	2005	Appendix 6, page 49: correction in eq. for vapour pressure in hPa
13 th Edition	4 November	2005	New Logo
14 th Edition	8 September	2006	Minor corrections
15 th Edition	24 October	2006	New Subchapters;
	p. 15		Conversion of Analogue Signals for Oxygen Optode 3975/4175
	p. 16		Conversion Calculations
	p. 32-33		Depth Compensation
16 th Edition	11 April	2007	p. 32-33 Depth Compensation corrections

NOTE! The latest version of the FAQ for the 3830 Oxygen Optode is available on our web site

© Copyright: Aanderaa Data Instruments AS

Contact information:

Aanderaa Data Instruments AS
 PO BOX 34, Slåtthaug
 5851 Bergen, NORWAY

Visiting address:
 Nesttunbrekken 97
 5221 Nesttun, Norway

TEL: +47 55 604800
 FAX: +47 55 604801

E-MAIL: info@aadi.no

WEB: <http://www.aadi.no>

Table of Contents

IMPORTANT!	5
INTRODUCTION	6
Purpose and scope	6
Document Overview	6
Applicable Documents	6
References	7
Abbreviations	8
CHAPTER 1 Short Description and Specifications	9
Manufacturing and Quality Control	11
CHAPTER 2 Operating Instructions	12
Hand-held Oxygen Optodes	12
The Oxygen Optode 3830 for mounting on Aanderaa Current meters/profilers	12
The Oxygen Optode 3930 used with buoys and sensor disks	13
Optode 3930 used with Data Buoy 4280	13
Optode 3930 used with Display Unit 3315	14
The Oxygen Optode 3975 used with analogue or serial output	14
Conversion of Analogue Signals for Oxygen Optodes 3975/4175	14
Conversion Calculations	15
Switch settings 0 - 5 V and 4 – 20 mA	15
CHAPTER 3 Communication with the sensor	17
Sensor integrated Software	17
RS232 protocol	18
Available subcommands and properties for the Oxygen Optode	20
Output Control	22
Scripting -sending a string of commands	24
Communication with the Oxygen Optode 3930	24
Communication with the Oxygen Optode 3975	26
OxyView	26
System requirements	26
Installation of the Software	27
Before start	27
About OxyView	27
The Menu Bar	28
The Graph Window	30
The Input Pane	30
The Output Pane	30
CHAPTER 4 Oxygen Calculations in the sensor	31
Salinity Compensation	32
Depth Compensation	32
CHAPTER 5 Maintenance	34

Sensing foil kit 3853	35
Calibration	35
Calibration Procedure using a terminal program	36
Appendix 1 Theory of Operation	38
Luminescence Decay Time	39
Appendix 2 The Optical Design	41
Appendix 3 Electronic Design	43
Appendix 4 Mechanical Design	44
Electrical Connections	45
Appendix 5 Optode Specifications	46
Oxygen Optode 3830	46
Oxygen Optode 3930	47
Oxygen Optode 3975	48
Appendix 6 Calibration Procedure -Primer	49
Appendix 7 Improve Accuracy of the Oxygen Optode 3975 (1-4V)	52
Appendix 8 Calculate the Oxygen Externally	54
Appendix 9 Illustrations	55
Appendix 10 Frequently Asked Questions -FAQ	61
Appendix 11 Oxygen Dynamics in Water	75
Seawater and Gases	75
Tables	75

IMPORTANT!

This manual describes the Oxygen Optode 3830, the Oxygen Optode/Temperature Sensor 3930 and the Oxygen Optode 3975.

However, the manual is also valid for the Oxygen Optode 3835, the Oxygen Optode/Temperature Sensor 4130 and the Oxygen Optode 4175. These Oxygen Optodes have a different housing and can only operate down to 300m, compared to the three first mentioned which can operate down to 6000, 1000 and 6000m, respectively.

Except for the different housing, the Oxygen Optodes are equal, in the way that:

- The Oxygen Optode 3835 equivalences the Oxygen Optode 3830.
- The Oxygen Optode/ Temperature Sensor 4130 equivalences the Oxygen Optode/Temperature Sensor 3930.
- The Oxygen Optode 4175 equivalences the Oxygen Optode 3975.

Please refer to Data sheet D355 for more information about the Oxygen Optodes 3835, 4130 and 4175, such as dimensions and weight.



3835



4130



4175

The Oxygen Optodes 3835, 4130 and 4175

INTRODUCTION

Purpose and scope

This document is intended to give the reader knowledge of how to operate, calibrate and maintain the Aanderaa Oxygen Optode 3830, Oxygen Optode/Temperature Sensor 3930 and Oxygen Optode 3975. It also aims to give insight in how these sensors work.

Since oxygen is involved in most biological and chemical processes in aquatic environments, it is the single most important parameter needing to be measured. Oxygen can also be used as a tracer in oceanographic studies.

For environmental reasons it can be critical to monitor oxygen in areas where the supply

of oxygen is limited compared to demand e.g.:

- In shallow coastal areas with significant algae blooms
- In fjords or other areas with limited exchange of water
- Around fish farms
- In areas interesting for dumping of mine or dredging waste

Document Overview

The document starts by giving a short description of the Oxygen Optodes.

Subsequently operating instructions, communication with the sensor, oxygen calculations and maintenance issues are presented.

The Appendix includes the principle behind the oxygen optodes, electronic and mechanical design, specifications, calibration procedures, illustrations, and finally a chapter on Frequently Asked Questions.

Applicable Documents

- Form 620 Test & Specification Sheet, Oxygen Optode
- Form 621 Calibration Certificate, O2 Sensing Foil 3853
- Form 622 Calibration Certificate, Oxygen Optode 3830
- Form 626 Calibration Certificate, Oxygen Optode 3930
- Data sheet D335, Oxygen Optode 3830, 3930, 3975
- Technical Note TN242, Disk 3829 for 5 Submersible Sensors

References

1. Berntsson M., A. Tengberg, P.O.J. Hall and M. Josefsson (1997). Multivariate experimental methodology applied to the calibration of a Clark type oxygen sensor. *Analytica and Chimica Acta*, 355: 43-53.
2. Demas J.N., B.A. De Graff, and P. Coleman (1999). Oxygen Sensors Based on Luminescence Quenching. *Analytical Chemistry*, 71: 793A-800A.
3. Diaz R. J. and R. Rosenberg (1995). Marine benthic hypoxia - review of ecological effects and behavioral responses on macrofauna. *Oceanography and Marine Biology, Annual Review*. 33:245-303.
4. Garcia and Gordon. 1992. Oxygen solubility in seawater: Better fitting equations *Limnology and Oceanography*: 37(6) :1307-1312.
5. Glud R.N., J.K. Gundersen, N.B. Ramsing (2000). Electrochemical and optical oxygen microsensors for in situ measurements. In *in situ monitoring of aquatic systems: Chemical analysis and speciation*. John Wiley & Sons Ltd (eds J Buffle & G Horvai). Chapter 2: 19-73.
6. Glud R.N., A. Tengberg, M. Köhl, P.O.J. Hall, I. Klimant (2001). An in situ instrument for planar O₂ optode measurements at benthic interfaces. *Limnology and Oceanography*, 46(8): 2073-2080.
7. Holst G., O. Kohls, I. Klimant, B. König, M. Köhl and T. Richter (1998). A modular luminescence lifetime imaging system for mapping oxygen distribution in biological samples. *Sensors and Actuators B*, 51, 163-170.
8. Joos, F., G.-K. Plattner, T. F. Stockner, A. Körtzinger and D. W. R. Wallace (2003). Trends in Marine Dissolved Oxygen: Implications for Ocean Circulation Changes and the Carbon Budget. *EOS*, 84.21: 187-194.
9. Kautsky H.(1939). Quenching of luminescence by oxygen. *Transactions of the Faraday Society*, 35:216-219.
10. Klimant I., V. Meyer and M. Kohls (1995). Fibre-optic oxygen microsensors, a new tool in aquatic biology. *Limnology and Oceanography*, 40, 1159-1165.
11. Stokes M.D. and G.N. Romero (1999). An optical oxygen sensor and reaction vessel for high-pressure applications. *Limnology and Oceanography*, 44(1), 189-195.
12. Tengberg A, J. Hovdenes, D. Barranger, O. Brocandel, R. Diaz, J. Sarkkula, C. Huber, A. Stangelmayer (2003). Optodes to measure oxygen in the aquatic environment. *Sea Technology*, 44(2).
13. TMS320LF/LC240xA DSP Controllers Reference Guide System and Peripherals, Texas Instruments, Literature Number: SPRU357A
14. Wolfbeis O.S. (1991). Fiber optic chemical sensors and biosensors. Volumes I+II, CRC Press, Boca Raton

15. Hiroshi Uchida, Takeshi Kawano, Ikuo Kaneko and Masao Fukasawa. In-Situ calibration of optode-based oxygen sensors. Submitted to Journal of Atmospheric and Oceanic Technology.

Abbreviations

O ₂	Oxygen molecule
LED	Light Emitting Diode
ADC	Analogue to Digital Converter
DSP	Digital Signal Processor
EPROM	Erasable Programmable Read Only Memory
ASCII	American Standard Code for Information Interchange
MSB	Most significant bit
UART	Universal Asynchronous Transmitter and Receiver
RTC	Real Time Clock

CHAPTER 1 Short Description and Specifications

The Aanderaa Oxygen Optode series consist of three sensors: 3830, 3930 and 3975.

- **Oxygen Optode 3830** is a digital Optode intended for mounting on Aanderaa Current meters/profilers. The sensor can also be used as a stand alone sensor, connected to a custom data logger via cable. In this case, use our 3485 cable for a depth capability of 1000m, or adaptor 3979 together with cable 3976 for a depth capability of 6000m.
- **Oxygen Optode 3930** comprise of the digital 3830 optode and an adaptor for sensor with 16mm foot (adaptor 3714). 3930 is intended as an immersion body for cable and sensor strings. The maximum operating depth is 1000m
- **Oxygen Optode 3975** comprise of the digital 3830 attached to an analogue adaptor (adaptor 3966) for analogue output. 3975 is intended as an immersion body with analogue and serial outputs. The maximum operating depth is 6000m

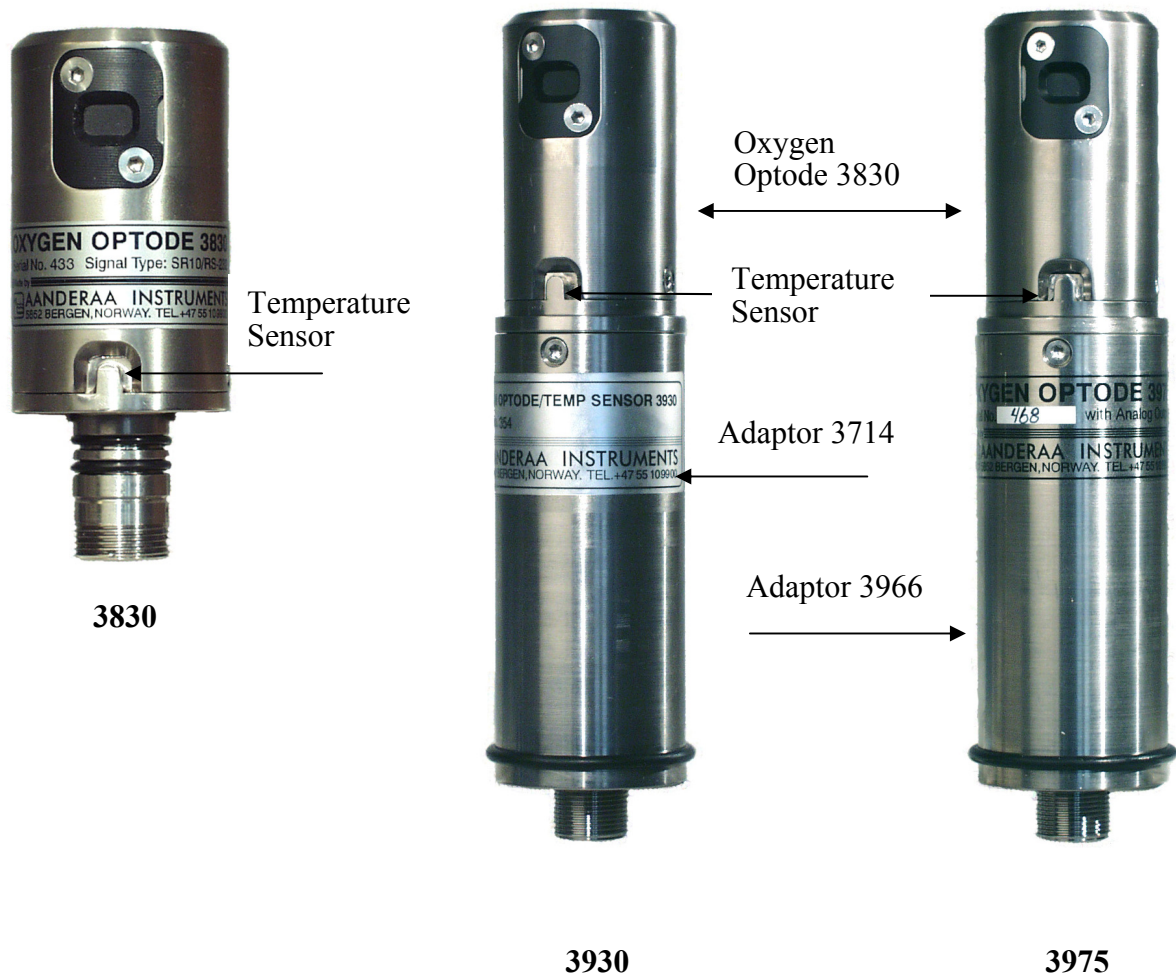

Figure 1 Illustration of the Oxygen Optode 3830 (to the left), 3930 (in the middle), and the 3975 (to the right)

The Aanderaa Oxygen Optode is based on the ability of selected substances to act as dynamic fluorescence quenchers.

The fluorescent indicator is a special platinum porphyrin complex embedded in a gas permeable foil that is exposed to the surrounding water. A black optical isolation coating protects the complex from direct incoming sunlight and fluorescent particles in the water.

The sensing foil is pushed against a sapphire window by a screw mounted securing plate, providing optical access to the measuring system from inside a watertight titanium housing.

The foil is excited by modulated blue light, and the phase of a returned red light is measured, ref Appendix 2. By linearizing and temperature compensating, with an incorporated temperature sensor, the absolute O_2 - concentration can be determined.

The lifetime-based luminescence quenching principle, as used in Aanderaa Oxygen Optodes, offers the following advantages over electrochemical sensors:

- Not stirring sensitive (it consumes no oxygen).

- Measures absolute oxygen concentrations without repeated calibrations. temperature, °C, and a number of raw data parameters.
- Better long-term stability (stable for at least one year).
- Less affected by pressure.
- Pressure behaviour is predictable and fully reversible.

The digital Optodes (3830 and 3930) output data in both RS232 and Aanderaa SR10 format (the 3930 must be opened, page 24). The analogue Optode (3975) outputs data as 0 - 5V or 4 - 20mA, and/or as RS232.

The Optodes can be logged directly by a PC (via the RS232 protocol) and by most custom made dataloggers and systems.

RS232 output the absolute oxygen content in μM , the relative air saturation in %, the

The SR10 output can be configured to present oxygen content in μM or air saturation when logged by an Aanderaa instrument (e.g. the Recording Current Meter, RCM 9 MkII or RCM 11, and the Recording Doppler Current Profiler, RDCP 600). Optode 3830 and 3975 are designed to operate down to 6000 meters.

NOTE! Optode 3930 can operate down to 1000 m.

For the Oxygen Optodes, the current drain is independent of the battery voltage (due to use of a linear regulator).

Refer Appendix 5 for general and specific specifications for all three optodes.

Manufacturing and Quality Control

Aanderaa Instruments have proven reliability. With over 30 years of producing instruments for the scientific community around the world, you can count on our reputation for designing some of the most reliable products available.

We are guided by three underlying principles: quality, service, and commitment. We take these principles seriously, for they form the foundation upon which we provide lasting value to our customers.

Our quality is based on a relentless program of continuous monitoring to maintain the highest standards of reliability.

CHAPTER 2 Operating Instructions

Hand-held Oxygen Optodes

All three optode versions can be used as Real-Time hand held sensors together with Aanderaa Instruments PC based Software *OxyView* for communication and presentation of measurements. Use sensor cable 3855 between the optode and the PC (Figure A 12, page 56). Refer CHAPTER 3 page 26 for information about *OxyView*. The RS232 signal from the optodes 3830 and 3975 is available from the sensor foot and the adaptor foot, respectively. To access the RS232 signal from the optode 3930 the housing has to be opened, refer page 24.

The Oxygen Optode 3830 for mounting on Aanderaa Current meters/profilers

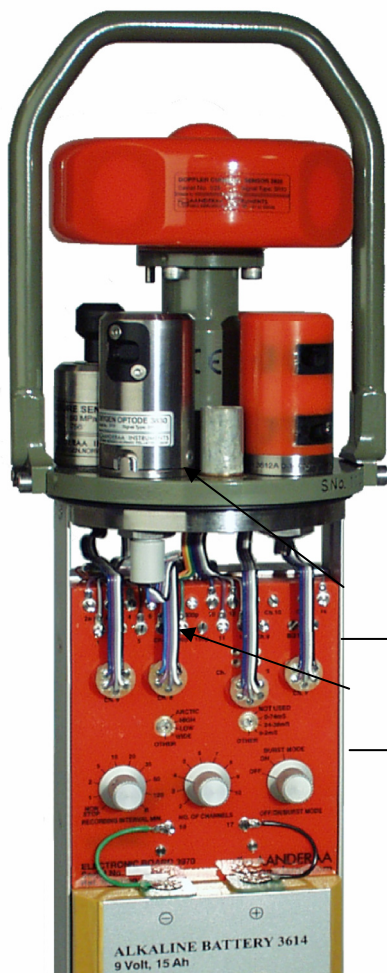

If the Oxygen Optode is ordered as part of an Aanderaa Current Meter/Profiler (RCM 9 MkII, RCM11 or RDCP600), the optode has been mounted to the instrument prior to delivery. Configurations have been made according to user requests.

However, if the optode has been ordered separately for use on an Aanderaa Current Meter/Profiler, follow the mounting and configuration descriptions given in the Operating Manual for the instrument.

Oxygen Optode 3830

Sensor Cable 3854

Figure 2 Oxygen Optode 3830 mounted on an RCM 9 Mk II

The Oxygen Optode 3930 used with buoys and sensor disks

The 3930 Optode can be used with Aanderaa datalogger series, as a sensor to Aanderaa Data Buoy 4280 or other Aanderaa self contained recording instruments like e.g. the Display Unit 3315 as stand-alone for single sensor measuring system.

Optode 3930 used with Data Buoy 4280

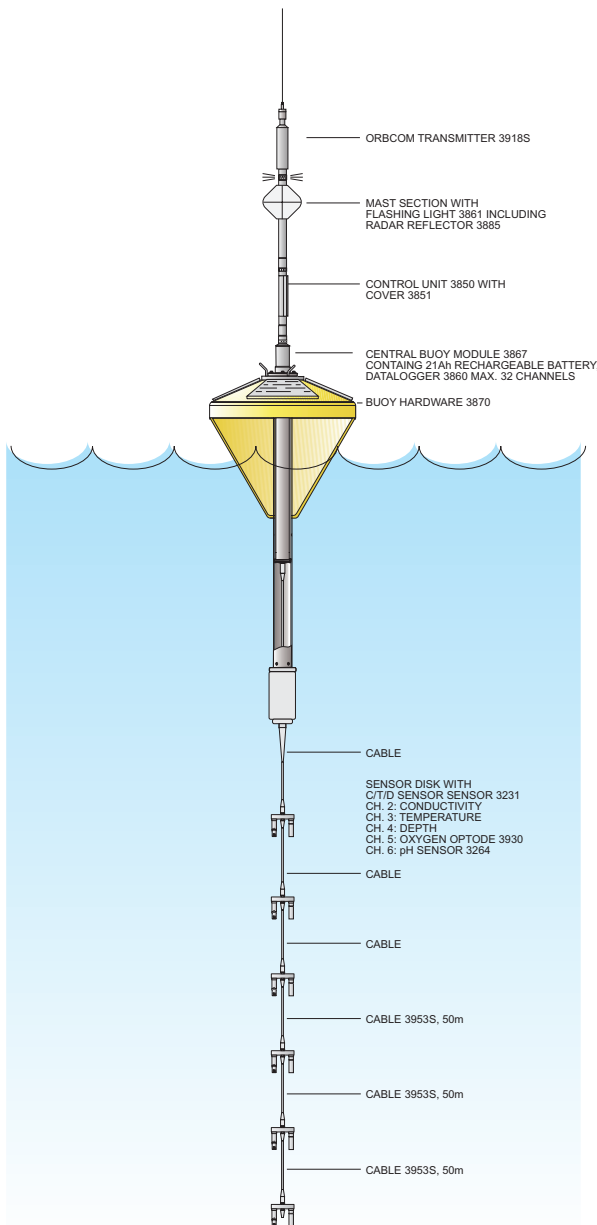

Figure 3 Illustration of one of our Buoy Deployment with Sensor Disk 3829 for 5 submersible sensors, like e.g. Oxygen Optode 3930.

When used in a Buoy Deployment, the Oxygen Optode 3930 can be mounted to Sensor Disk 3829 as illustrated in Figure 3.

The Sensor Disk is connected to a sub sea cable. Measurements are configured in the datalogger, e.g. Aanderaa Datalogger 3860.

Ref. Operating Manual TD 216 for communication with datalogger 3860.

Sensor Disk 3829 is designed for up to 5 submersible sensors, refer Figure 4. The Sensor Disk is fitted with Aanderaa standard 10-pin receptacles and an internal switch for presetting of the number of channels in use for each sensor connected. For connection and disconnection of sensors to the Sensor Disk, ref Technical Note TN 242.



Figure 4 sensor Disk 3829

Optode 3930 used with Display Unit 3315

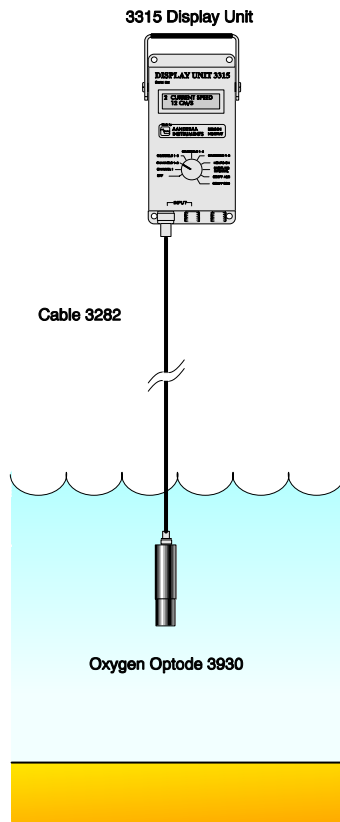

For a single sensor measuring system, the Oxygen Optode 3930 can be connected to a Real-Time Display Unit 3315 via cable 3282, as illustrated in Figure 5.

In cases where two or more sensors are needed we strongly recommend to connect the sensors to Aanderaa Sensor Disk 3829 (refer Figure 4). Use Cable 3809 between the Sensor Disk and the Display Unit.

Sensor Configurations are performed on the Display Unit.

Figure 5 Display Unit 3315 used with a submersible sensor like e.g. Oxygen Optode 3930.

The Oxygen Optode 3975 used with analogue or serial output

The Oxygen Optode 3975 can be used with third party dataloggers, e.g. CTD's, ARGO floats, ROV's, PLC's, process industry controllers, recorders, and data acquisition and control systems. For connection of sensors to these systems, refer to the specific systems Operating Manual.

Conversion of Analogue Signals for Oxygen Optodes 3975/4175

The Oxygen Optode 3975/4175 is a unit consisting of the Oxygen Optode 3830/3835 and Analog Adaptor 3966. The Analog Adaptor 3966 converts the signals from the Optode 3830 to either 0 to 5V or 4 to 20mA signals.

Table 2-1 gives the range, accuracy and resolution of the Analog Adaptor 3966 when used with Oxygen Optode 3830/4175.

Table 2-1 Output specifications for the analogue signal

Parameter	Output	Range	Accuracy	Resolution
Oxygen Concentration	0 - 5V	0 to 500µM	<8µM or 5% whichever is greater	< 1µM
	4 - 20mA	0 to 500µM	<9µM or 5.2% whichever is greater	< 1µM
Oxygen Saturation	0 - 5V	0 - 120% ¹⁾	<5 %	<0.4%
	4 - 20mA	0 - 120% ¹⁾	<5.2 %	<0.4%
Temperature	0 - 5V	0 - 36°C ²⁾	±0.1°C	±0.01°C
	4 - 20mA	0 - 36°C ²⁾	±0.15°C	±0.02°C

¹⁾ The full saturation range of the analog output is 0 to 150%; however the accuracy above 120% may be reduced compared to the specified accuracy.

²⁾ The full temperature range of the analog output is -5 to 40°C; however the accuracy outside the 0 to 36°C range may be reduced compared to the specified accuracy.

Conversion Calculations

From voltage (V_{out}) to temperature (°C):..... $T = \frac{V_{out} \cdot 45^*}{5} - 5$

From voltage (V_{out}) to Air Saturation (%):..... $AirSat = \frac{V_{out}}{5} \cdot 150$

From voltage (V_{out}) to Oxygen Concentration (µM): $Cons = \frac{V_{out}}{5} \cdot 500$

From current (I_{out}) to temperature (°C): $T = \frac{(I_{out} - 4) \cdot 45^*}{16} - 5$

From current (I_{out}) to Air Saturation (%):..... $AirSat = \frac{I_{out} - 4}{16} \cdot 150$

From current (I_{out}) to Oxygen Concentration (µM): $Cons = \frac{I_{out} - 4}{16} \cdot 500$

* For all Optodes with software version 2.71 or higher, temperature range -5 to 40°C, use 45, for all other versions with software version 2.70 or lower, temperature range 0 to 40°C, use 40

Switch settings 0 - 5 V and 4 – 20 mA

A dipswitch contact is *OFF* when the switch is in the upper position. The three valid settings are shown in Figure 6, Figure 7, and Figure 8. Note that when the Analogue Adaptor 3966 is switched off by setting contact no. 8 in the *OFF* position, the sensor connected to the adaptor is still powered. The RS232 lines are wired straight through the analogue adaptor and are thus not affected by the switch settings. Refer Table 3-4, page 23 for channel output.

Table 2-2 Switch settings for Optode 3975

Switch	Function	Remarks
1	Enable 4 – 20mA	Output 1
2	Enable 0 – 5V	
3	Power, 4 – 20mA transmitter	
4	Enable 4 – 20mA	Output 2
5	Enable 0 – 5V	
6	Enable 4 – 20mA voltage ref	
7	Enable 0 – 5V voltage ref.	
8	Power	

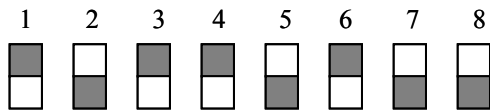

Figure 6 Switch setting for 0 – 5 V analogue output (the dark square represents the switch). Upper position is OFF.

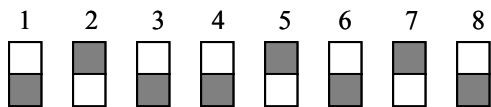

Figure 7 Switch setting for 4 – 20 mA analogue output (the dark square represents the switch). Upper position is OFF.

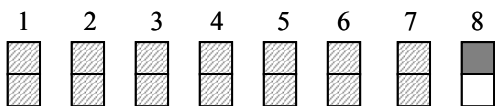

Figure 8 Switch setting for switching the analogue adaptor off (the dark square represents the switch). Upper position is OFF.

CHAPTER 3 Communication with the sensor

For communication with the sensor we recommend you to use OxyView software, which is available for a nominal license fee. The software is user friendly and provides graphic and tabular display for set-up, calibration, and logging. These functions are easily accessed without deeper knowledge about the sensor. Read more about OxyView on page 26.

As an alternative you can also communicate with the sensor using any standard Terminal communication program (such as HyperTerminal included in Windows or

Terra Terminal). Read the guidelines carefully and type in every command separately. Refer page 18 for guidelines.

NOTE! We recommend that you write standard lines in a text document and copy the text lines into the terminal program, refer page 24. You can also copy lines from a text editor and paste into the Terminal program.

The standard factory setting is SR10 output from the Optodes (unless other arrangements has been made).

Sensor integrated Software

The sensor integrated software's main tasks are to control the transmitter, sample the returned signal, extract the phase of this signal, and convert it into oxygen concentration and/or Air Saturation.

All properties that can be changed for each individual sensor, i.e. calibration coefficients, are called sensor properties. The properties can be displayed and changed using the RS232 port (refer the *RS232 protocol*, page 18, for how to communicate with the sensor using a Terminal communication Program).

The Oxygen Optode will perform an oxygen sample and present the result within the first 1.5 seconds after the optode has been powered up.

The RS232 input buffer is checked for 100 milliseconds after each sample (including the first sample).

If the buffer contains any characters the timeout is increased to 1 second and the software starts interpreting the RS232 input.

If the input buffer is empty the sensor will continue to sample and present data according to the setting of the *Interval* property.

If the *Interval* is set to zero the user can initiate a new sample by use of a *Do_Sample* command. Figure 9 illustrates the operation sequence.

After approximately 20 seconds without valid command inputs the sensor enters sleep mode until the next interval starts.

In sleep mode the sensor will not respond to RS232 input commands. If the time interval is long, the best way to start communication with the sensor is to first disconnect and then reconnect the power to the sensor.

However, before entering sleep mode the sensor stops the host's transmission by sending out a *XOFF* handshake-control character.

After waking up and finishing the next sample, the host transmission is switched back on.

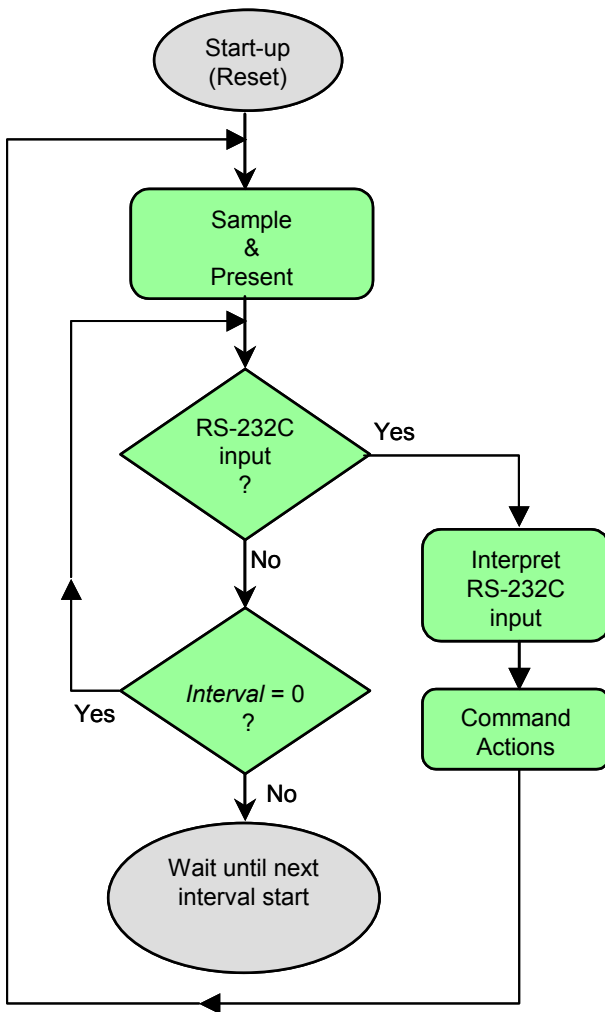

Figure 9 Operational Sequence of the internal Software

When the handshake method is used the host's output will be buffered until the sensor is ready to receive.

This relieves the host from the need to synchronize the communication with the sensors sampling interval.

When the Optode is connected to an Aanderaa Instrument or datalogger, the power to the sensor is switched *ON* as the Control Voltage becomes active (initiated by the Instrument or the datalogger).

The sensor will then take one sample in the start of the recording interval and present this at the SR10 output.

When the datalogger has finished reading the SR10/VR22 sensors, the Control Voltage is switched *OFF* and the Optode is powered down.

RS232 protocol

The RS232 protocol describes how to communicate with the sensor.

For connection to a PC the 1.5-meter Sensor Cable 3855 can be used (Figure A 12, page 56).

Most terminal programs, such as e.g. the *HyperTerminal**) by Hilgraeve Inc (included in Microsoft operating systems), can be used for communication with the sensor.

All commands described in this chapter are available by single mouse clicks in OxyView Software.

The following RS232 setup should be used for the terminal setup:

9600 Baud

8 Data bits

1 Stop bit

No parity

Xon/Xoff Handshake

NOTE! Select the options 'Sent line ends with line feeds' and 'Echo line ends with line feeds' in the Hyper Terminal.

All communication is ASCII coded with the following rules:

All inputs to the sensor are given as commands with the following format:

- *MainCmd_SubCmd* or *MainCmd_Property(Value., Value)*
- The main command, *MainCmd_SubCmd* is followed by an optional subcommand (*SubCmd*) or sensor property (*Property*).
- The *MainCmd* and the *SubCmd/Property* must be separated with the underscore character ‘_’ or a space ‘ ’ character.
- When entering new settings the *Property* is followed by a parentheses containing comma-separated values.
- The command string must be terminated by a Line Feed character (ASCII code 10). Termination with Carriage Return followed by Line Feed is also allowed.
- The command string is not case sensitive (UPPER/lower-case).
- A valid command string is acknowledged with the character ‘#’ while character ‘*’ indicates an error. Both are followed by Carriage Return/ Line Feed (CRLF).

For most errors a short error message is also given subsequent to the error indicator.

The RS232 protocol describes how to communicate with the sensor. All inputs to the sensor are given as commands; a list of the main commands are given in Table 3-1 (next page).

NOTE!

Losing power during the flashing process can cause corruption of vital settings, such as coefficients, serial number, model number etc. If losing power, contact AADI for new setting file for the specific optode with further instructions.

Flashing is carried out when running the Do_CalAir, DO_CalZero, Do_Calibrate and Save commands.

Table 3-1 Main RS232 commands available for the Oxygen Optode.

Command	Description
<i>Do_Subcmd</i>	Execute Subcmd (refer Table 3-2)
<i>Get_Property</i>	Output Property value (refer Table 3-3)
<i>Get_All</i>	Output all property values
<i>Set_Property(Value,... Value)</i>	Set Property to Value,... Value
Save	Store current settings
Load	Load stored settings
Help	Print help information

Available subcommands and properties for the Oxygen Optode

Available subcommands and properties for the Oxygen Optodes are given in Table 3-2 and Table 3-3 respectively.

Table 3-2 Available Subcommands for the Oxygen Optode

Subcommand	Description	Write Protection
Sample	Execute an oxygen measurement and presents the result	No
Calibrate	Execute calibration function	Yes
CalAir	Collect calibration data in air	Yes
CalZero	Collect calibration data in zero solution	Yes
Test	Execute a test function and present the result	No

A property may contain one or more equal elements of the type Character, Integer or Float. The Character type is stored as an 8-bit bit word and may be signed (value –128 to 127) or unsigned (0-256).

The Integer type is stored as a 16-bit word and may be signed (value –32768 to 32767) and unsigned (0 to 65535).

The Float consists of 32-bit and has a range from 1.19209290e–38 to 3.4028235e+38.

The *Get* command is used for reading the value/values of a property.

The command name *Get*, is followed by *_Property* and returns a string on following format:

Property ProductNo SerialNo Value, ..Value

The string starts with the name of the property (*Property*), continues with the product number and serial number of the sensor, and finally the value or values of the property.

All names and numbers are separated by tabulator spacing (ASCII code 9).

The string is terminated by Carriage Return and Line Feed (ASCII code 13 & 10).

Example:

```
Get_Salinity
```

Returns:

```
Salinity 3830 116 3.500000E+01 #
```

A special version, Get_All, reads out all available properties in the sensor.

Table 3-3 Available Properties for the Oxygen Optode; NA = Not Applicable

Properties	Type	No. of elements	Use	Write protection	Default setting
<i>Protect</i>	Int	1	Protection of property read and write access	No	0
<i>PhaseCoef</i>	Float	4	Curve fitting coefficients for phase measurements	Yes	NA
<i>TempCoef</i>	Float	4	Curve fitting coefficients for temperature measurement	Yes	NA
<i>FoilNo</i>	Int	1	Foil batch number	Yes	NA
<i>C0Coef</i>	Float	4	Temperature Coefficients in the [O ₂] phase	Yes	NA
<i>C1Coef</i>	Float	4		Yes	NA
<i>C2Coef</i>	Float	4		Yes	NA
<i>C3Coef</i>	Float	4		Yes	NA
<i>C4Coef</i>	Float	4		Yes	NA
<i>Salinity</i>	Float	1	Salinity setting	No	0
<i>CalAirPhase</i>	Float	1	Calibration data in air, phase	Yes	NA
<i>CalAirTemp</i>	Float	1	Calibration data in air, temperature	Yes	NA
<i>CalAirPressure</i>	Float	1	Calibration data in air, pressure	Yes	NA
<i>CalZeroPhase</i>	Float	1	Calibration data in zero solution, phase	Yes	NA
<i>CalZeroTemp</i>	Float	1	Calibration data in zero solution, temperature	Yes	NA
<i>Interval</i>	Int	1	Sample Interval in seconds.	No	30
<i>AnCoef</i>	Float	2	Offset and slope correction coefficients for I2C output to Analogue Adaptor	Yes	0,1
<i>Output</i>	Char	1	Output setting	Yes	-1

The *Set* command is used for changing a property.

Example:

```
Set_TempCoef(-124,1.6644E-4, 3.3456E-12,0)
```

Returns:

```
#
```

Float values may be entered on normal decimal form or exponential form, either with ‘e’ or ‘E’ leading the exponent. Extra ‘Space’ characters in front or after a value are allowed.

When one or more properties are changed, the sensor will start using the new properties.

If the *Save* command is executed the new setting will be stored in the internal EEPROM.

If a *Load* is executed instead, the previous stored setting will be reloaded.

To avoid accidental change, most of the properties are write-protected.

A special property called *Protection* must be set to 1 before changing the value of properties with this write protection.

The *Protection* property always returns to zero after power up or execution of the *Load* or *Save* command.

The *Do_Sample* command or an interval initiated measurement result in one output string containing the obtained data.

Output Control

A property called *Output* controls the presentation of the measured data. When the *Output* value is set to 1 a comprehensive RS-232 string containing raw data is presented:

MEASUREMENT	3830	392	Oxygen:	277.04	Saturation:	98.12
Temperature:	20.22		Dphase:	26.90	Bphase:	27.40
Rphase:	0.00		Bamp:	319.97	Bpot:	222.00
Ramp:	0.00		RawTem.:	-18.81		

When the *Output* property is set to 0 a normal string with the following format is transmitted:

MEASUREMENT	3830	104	Oxygen:	234.87	Saturation:	104.75
Temperature:	28.78					

If the *Output* is set to 100 or 101 the output string is as for the 0 and 1 setting but with all the text removed: The leading word, MEASUREMENT, is followed by the sensor’s product number

and serial number. All words and numbers are followed by a tabulator spacing (ASCII code 9). The string is terminated by Carriage Return and Line Feed (ASCII code 13 and 10).

Setting a negative *Output* property value enables either the SR10 outputs or the I2C output to the Analogue Adaptor, refer Table 3-4.

Table 3-4 Negative Output properties for the Oxygen Optodes (Positive Outputs 0, 1, 100, 101 gives RS232 Output and are described in the text above).

Output	Data on SR10 Output	Unit/scaling coefficients	Data on Analogue Adaptor; Output 1	Data on Analogue Adaptor; Output 2
-1	O ₂ Concentration	[μ M] A = 0 B = 0.488281		
-2	O ₂ Saturation	[%] A = 0 B = 0.146484		
-100	Test, fixed reading	777		
-101			O ₂ Concentration	Temperature
-102			O ₂ Saturation	Temperature
-103			Calibrated phase measurement ¹ (ref CHAPTER 4)	Temperature
-110			Test, fixed reading 4V/16.8mA	Test, fixed reading 1V/7.2mA
-111			Test, fixed reading 1V/7.2mA	Test, fixed reading 4V/16.8mA

NOTE!

The Oxygen Optode 3975 has analogue outputs: 0-5 Volt or 4-20 mA. Refer page 14 for dip-switch settings for the analogue adaptor.

When the analogue output or the SR10 output is enabled, all measurements are also presented at the RS232 port.

After the very first sample additional information about setting and scaling coefficients are presented. An example of information and scaling coefficients for Oxygen Optode 3830 are given next:

¹ Temperature compensation is done externally by the user, often used in oxygen profiling, refer Appendix 8.

MEASUREMENT	3830	104	Oxygen:	234.87	Saturation:	104.75.....
0-5V Output 1:	Oxygen 1.367 V, use scaling coef. A:= 0.000000E+01 B:= 6.600000E+00					
0-5V Output 2:	Temperature 3.766 V, use scaling coef. A:=-5.000000E+00 B:= 8.000000E+00					
4-20mA Output 1:	Oxygen 6.56 mA, use scaling coef. A:= 1.175000E+01 B:= 2.062500E+00					
4-20mA Output 2:	Temperature 16.05 mA, use scaling coef. A:=-1.500000E+01 B:= 2.500000E+00					

Scripting -sending a string of commands

Often it may be usefully to collect more than one command in a text file. For example the instructions below can be written in an ordinary text editor and saved as a text file, which can be sent to the sensor. In the HyperTerminal click *send text file* in the *Transfer* menu, and select the correct file.

Example of text file:

```
// Set sampling interval to 30 seconds
Set_Protect(1)
Set_Interval(30)
Save
Get_All
```

NOTE! The last line, Get_All, reads out available properties for the sensor.

The first line is a comment line that is disregarded by the sensor. Strings starting with either ‘//’ or ‘;’ are ignored by the software, and do not produce errors or acknowledgements.

Communication with the Oxygen Optode 3930

In order to change settings or to calibrate Optode 3930 the sensor has to be connected to a PC.

Note! New 3930 sensors do not have the securing ring, ref. Figure 1. The RS232 signal can be accessed by following the outlined procedure, neglecting the text regarding the securing ring.

Follow the procedure given below to gain access to the Optode’s RS232 signals:



Figure 10

1. Remove the setscrew, refer Figure 10
2. Unscrew the black securing ring, refer Figure 11.

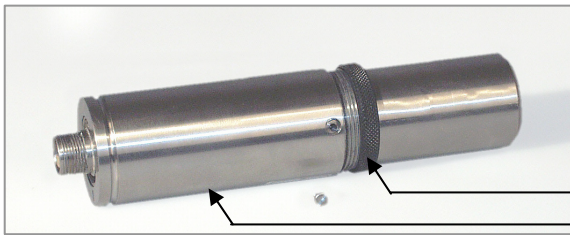

Figure 11

3. Remove the cylindrical body by pulling upwards towards the sensor receptacle, refer Figure 11.

securing ring
cylindrical body



Figure 12

4. Gently pull out the internal plug connected to the Optode, refer Figure 12, Figure 13, and Figure 14.



Figure 13

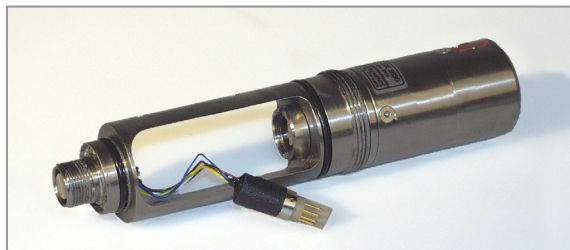

Figure 14

5. Use Sensor Cable 3855 to carefully connect the Optode to the serial connector of a PC, refer Figure 15, Figure 16, and Figure 17.

Refer page 18, *RS232 protocol*, for communicating with the sensor.



Figure 15

Reassemble the housing in reverse order after calibration and/or settings have been performed. Please make sure that both O-rings in the Optode housing are clean and undamaged. If necessary: change the O-rings.

Remount the setscrew before tightening the securing ring.

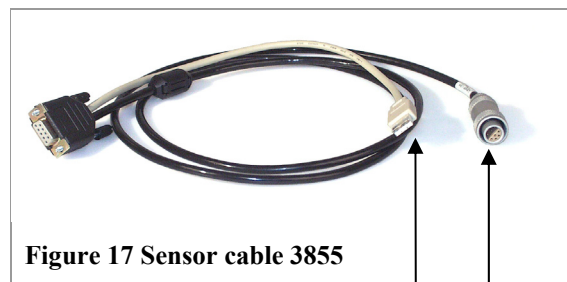

Serial port for PC

USB Connection to supply the sensor with power
(5-14V possible)

Connection for sensor

NOTE! Many new PC's do not have a serial port. Use an USB/serial Adaptor for the connection.

Communication with the Oxygen Optode 3975

The RS232 signal is accessed from the adaptor foot directly. For communication with the sensor via OxyView or Hyper Terminal, connect sensor cable 3855 between the adaptor foot and the COM port on your PC.

OxyView

OxyView is a Windows Application designed for use with the Oxygen Optode in Real-Time situations. The program is intuitive, and will allow display of Oxygen Concentration, Oxygen Saturation and Temperature in table and graphical form.

Included in the software is a Calibration Wizard to help calibrate Oxygen Optode sensors.

System requirements

- 233 MHz or faster Pentium or compatible
- 1MB of free hard disk space
- Microsoft Windows 98, 2000 or XP
- 64MB of RAM
- SVGA (640x480) colour display

- Local CD-ROM Drive
- Internet Explorer (4.0 or later)

Installation of the Software

To install OxyView, run *OxyView setup.exe* found on the product CD. This will install OxyView in a program folder on your machine. In the same folder, a help file and an operating manual can be found.

To uninstall OxyView, run *unwize.exe* found in the same folder as *OxyView.exe*.

If you have an old version of OxyView uninstall this one before installing the latest version (run *unwize.exe*).

Before start

At startup OxyView tries to establish a connection with the Oxygen Optode by sending *Get_Interval* commands. If the sensor is in sleep mode it will not respond to RS232 commands before the sampling interval elapses.

If the interval is greater than about 60 seconds, OxyView will not be able to get information regarding the sampling interval and will then create a graph assuming that the time between ticks is 2 seconds.

To force the sensor out of sleep mode, disconnect and reconnect the power to the sensor (normally the USB plug on your PC will supply 5V).

NOTE!

Losing power during the flashing process can cause corruption of vital settings, such as coefficients, serial number, model number etc. If losing power, contact Aanderaa Data Instruments for new setting file for the specific optode with further instructions.

Flashing is carried out when running the Do_CalAir, DO_CalZero, Do_Calibrate and Save commands.

About OxyView

The OxyView user interface consists of four main parts:

- The Menu Bar
- The Graph Window
- The Input Pane
- The Output Pane

The Menu Bar

The most important Menu Items are:

- View Settings
- DAQ Settings
- Tools

The *View Settings* menu enable users to modify graph settings like time scale, Y-scale, line colour etc.

Table 3-5 Commands available in the View settings Menu.

Commands	Description
Plots	<p>By default, OxyView display three graphs, refer Figure 18:</p> <ul style="list-style-type: none"> <input type="checkbox"/> Oxygen Concentration <input type="checkbox"/> Oxygen Saturation <input type="checkbox"/> Temperature <p>Use the <i>Plot</i> command to add or remove plots. A check mark to the left of a plot name indicates that the plot line is displayed. Click on the plot name to add or hide the plot line.</p>
Plot Settings	Use the <i>Plot Settings</i> command to bring up a dialog that enables the user to modify the color, style or the y-axis scale for the individual plot lines, refer Figure 19.
SetGraphRange	Use the <i>SetGraphRange</i> command to bring up a dialog that enables the user to modify the range of the time axis.
Run/Stop	Use the <i>Run/Stop</i> command to start or stop sampling. <i>Shortcut key: SPACE</i>

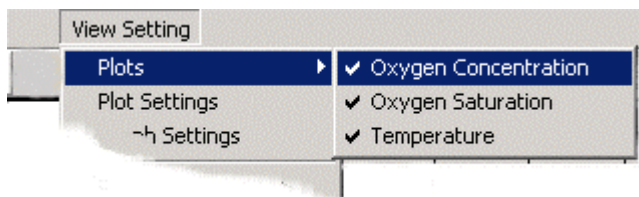

Figure 18 View Setting Menu

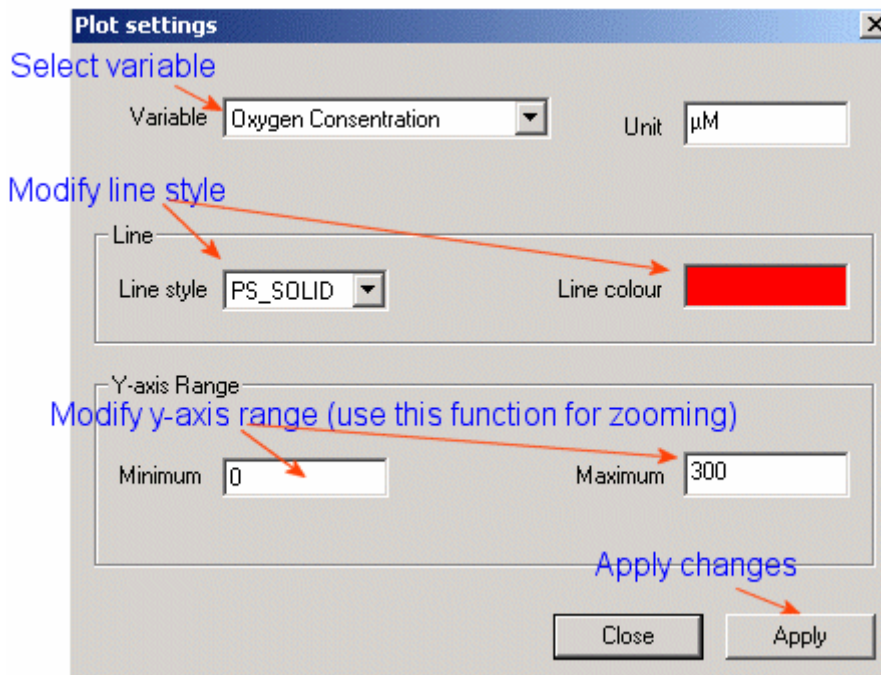

Figure 19 Plot Settings

The *DAQ settings* menu enables users to set sample interval, to start logging of data to file and to change COM port.

Table 3-6 Commands available in the DAQ settings Menu.

Commands	Description
COM port	Use the <i>COM port</i> command to select another serial port.
Logging	Use the <i>Logging</i> command to enable logging of data and to specify the path to and the name of the data file (text file with tab delimiter).
Sample Interval	Use the <i>Sample Interval</i> command to bring up a Set Sampling Interval dialog. Note that clicking on the watch symbol at the short cut toolbar brings up the same dialog.

From the *Tools* menu the user can start a Calibration Wizard and the Command Tool Dialog. By use of the Command Tool Dialog, the user can run all command supported by the Oxygen Optode Sensor. When clicking on a command, its function is fully explained in a dialogue box. Note that most users do not need to use this tool. For more information about these commands, refer page 20 to 24.

Table 3-7 Commands available in the Tools Menu.

Commands	Description
Calibrate	Invoking the <i>Calibrate</i> command to bring up the calibration wizard. Follow the instructions on the screen to perform a one or two point calibration of the sensor. <i>Shortcut: Press the weight symbol on the short cut toolbar.</i>
Run	Invoke the <i>Run</i> command to bring up a dialog box that enables the user to run all commands supported by the Oxygen Optode Sensor. Select command, sub-command or property. Enter property values if necessary and press send. <i>Note that most users do not need to use this tool.</i>

The Graph Window

The Graph Window displays plot lines for Oxygen Concentration, Oxygen Saturation and temperature with separate y-axis scales to the right of the graph.

The Input Pane

Text strings (raw data) arriving from the Oxygen Optode Sensor are presented in this pane.

The Output Pane

Text strings sent from OxyView to the Oxygen Optode Sensor are presented in this pane.

CHAPTER 4 Oxygen Calculations in the sensor

The Optodes internal software calculates engineering values (calibrated oxygen concentrations) based on the sampled raw-data and a set of stored ('flushed') coefficients.

After converting the phase raw data to degrees, a calibrated phase measurement (DPhase) is calculated as a 3rd degree polynomial of the uncalibrated phase measurement. The uncalibrated phase measurement is the difference between the phase obtained with blue light excitation (BPhase) and the phase obtained with red light excitation (RPhase).

Note! The red light excitation will normally not be used and RPhase is then set to zero.

The coefficients in the above polynomial are stored in the property (setting) called PhaseCoef.

Note! Usually only the first two (1 degree) coefficients are calculated when the internal calibration function is used.

The temperature, °C, is calculated from a similar polynomial with coefficient called TempCoef.

The O₂-concentration is calculated in micro Molar, μM, from a 4th degree polynomial:

$$[O_2] = C_0 + C_1P + C_2P^2 + C_3P^3 + C_4P^4$$

where C₀,...,C₄ = temperature dependent coefficients calculated as:

$$C_x = C_{x0} + C_{x1}t + C_{x2}t^2 + C_{x3}t^3$$

The C_{x0},...,C_{x3} coefficients are stored in the properties called

C0Coef_{0..3}

C1Coef_{0..3}

C2Coef_{0..3}

C3Coef_{0..3}

C4Coef_{0..3}

P = calibrated phase measurement (DPhase).

Based on O₂-concentration, temperature and salinity setting, the Calculate function also calculates the relative O₂ saturation.

The following equation by Garcia and Gordon, ref page 7, gives the O₂ solubility (C*) at standard air mixture and pressure (1013 hPa).

$$\ln(C^*) = A_0 + A_1T_s + A_2T_s^2 + A_3T_s^3 + A_4T_s^4 + A_5T_s^5 + S(B_0 + B_1T_s + B_2T_s^2 + B_3T_s^3) + C_0S^2$$

where:

T_s = scaled temperature

$$= \ln \left[\frac{298.15 - t}{273.15 + t} \right]$$

t = Temperature, °C

S = Salinity (fixed setting)¹

$$A_0 = 2.00856 \quad B_0 = -6.24097e-3$$

$$A_1 = 3.22400 \quad B_1 = -6.93498e-3$$

$$A_2 = 3.99063 \quad B_2 = -6.90358e-3$$

$$A_3 = 4.80299 \quad B_3 = -4.29155e-3$$

$$A_4 = 9.78188e-1 \quad C_0 = -3.11680e-7$$

$$A_5 = 1.71069$$

The relative O₂ saturation in % can now be calculated as:

$$O_{2Sat} = \frac{[O_2] \cdot 2.2414}{C^*}$$

¹ Default setting for salinity is zero

where:

$[O_2]$ = O₂-concentration, μM

C^* = Solubility, $cm^3/liter$

Salinity Compensation

The O₂-concentration sensed by the Optode is the partial pressure of the dissolved oxygen.

Since the foil is only permeable to gas and not water, the Optode can not sense the effect of salt dissolved in the water, hence the Optode always measures as if immersed in fresh water.

If the salinity variation on site is minor (less than ± 1 ppt), the O₂-concentration can be corrected by setting the internal property *Salinity* to the average salinity at the measuring site.

However, if the salinity varies significantly and a measured salinity is available a more accurate correction may be applied by a post compensation of the data.

The O₂-concentration, μM , should then be multiplied by the following factor:

$$O_{2c} = [O_2] \cdot e^{S(B_0 + B_1 T_s + B_2 T_s^2 + B_3 T_s^3) + C_0 S^2}$$

where:

S = salinity in ppt

T_s = scaled temperature

$$= \ln \left[\frac{298.15 - t}{273.15 + t} \right]$$

t = temperature, $^{\circ}C$

$$B_0 = -6.24097e-3 \quad C_0 = -3.11680e-7$$

$$B_1 = -6.93498e-3$$

$$B_2 = -6.90358e-3$$

$$B_3 = -4.29155e-3$$

If the Salinity setting in the Optode is set to other than zero (zero is the default value), the formula becomes:

$$O_{2c} = [O_2] \cdot e^{(S-S_0)(B_0 + B_1 T_s + B_2 T_s^2 + B_3 T_s^3) + C_0 (S^2 - S_0^2)}$$

Where S_0 is the internal salinity setting

Depth Compensation

The response of the sensing foil decreases to some extent with the ambient water pressure (3.2% lower response per 1000 m of water depth or dbar –see reference 15 on page 8).

This effect is however totally and instantly reversible and easy to compensate for. When using depth in meters or pressure in dbar the following equation:

$$O_{2c} = O_2 \cdot \left(1 + \frac{0.032 \cdot d}{1000} \right)$$

where:

d is depth in meters or pressure in dbar.

O_{2c} is compensated O₂-concentration in either μM or %, depending on the unit of the O₂ input.

NOTE! Depth Compensation is not performed within the Optode.

Examples of compensation when using dbar:

At normal atmospheric pressure (1013 mbar) no pressure compensation should be done. Then as you submerge your sensor, for every meter (or dbar) that you move deeper into the water you should make a 0.0032% pressure compensation per dbar increase of the relative pressure.

The relative pressure = absolute pressure (measured with your sensor) – atmospheric pressure (normally set to 1013 mbar).

Measured O₂-concentration with optode = 400 μM

Depth = 1m = 1dbar relative pressure

Compensated value = $400 \times 1.000032 = 400.012 \mu M$

Measured O₂-concentration with optode = 400 μM

Depth = 1000m = 1000dbar relative pressure

Compensated value = $400 \times 1.032 = 412.8 \mu M$

CHAPTER 5 Maintenance

The Oxygen Optode requires very little maintenance.

When the membranes on traditional oxygen consuming sensors (based on electrochemical principles), often called Clark sensors, are fouled the water mixing in front of the sensor membrane becomes poorer, which influences the measurement directly.

Since the Optode consumes no Oxygen, the ability to diffuse gas has no influence on the measurement accuracy.

However, if the fouling is in the form of algae that produce or consume oxygen, the measurement might not reflect the oxygen concentration in the surrounding water correctly.



Figure 20 Example of fouling on an RCM 9 Mk II with an Oxygen Optode 3830 mounted to it: The Optode was still giving correct readings.

Also the response time of the measurements might increase if the sensing foil is heavily fouled.

Therefore, the sensor should be cleaned at regular intervals from 1 month to a year depending on the required accuracy and the fouling condition at the site.

The Optode housing can be cleaned using a brush and clean water. Carefully, use a wet cloth to clean the sensing foil.

Fouling consisting of calcareous organisms (e.g. barnacles), can be dissolved by dipping the sensor/instrument in a weak acid solution (e.g. 7% Vinegar).

If the sensing foil is scratched or if the protective black layer on the foil is removed the sensor will still work as long as there is enough Fluorophore on the foil.

If severely damaged (so that the sensor gives unrealistic readings) the sensing foil should be replaced (Sensing Foil Kit 3853) and the sensor recalibrated.

NOTE! Enter new calibration coefficients when changing the sensor foil.

Due to the measurement technology, the optodes do not drift over time (within the given specifications).

It is recommended that the sensor is recalibrated annually (refer next section), although feedback tells us that the sensors are stable over a longer time period.

Sensing foil kit 3853

If the sensing foil gets damaged and has to be changed you need the Sensor foil Kit 3853. The content of Kit 3853 is given in Table 5-1, and a procedure for changing the foil is given below the table.

NOTE! If you use a foil from a different batch, new calibration coefficients must be entered. If not, the sensor will be inaccurate and there is no way of post compensating your data.

Table 5-1 Contents of Sensor Foil Kit 3853

Part no.	Pieces	Description
962203	2	Sensing Foil packed in aluminium foil
642710	2	Hex countersink screw 3 x 6mm Din 7991 A4
913015	1	2mm Hex Key
Form No. 621	Calibration Sheet for Sensing Foil (each batch of foils is calibrated)	

Procedure for changing the sensor foil:

- The Sensor Foil is changed by unscrewing the 2 hex screws in the securing plate, refer Figure A 1. Remove the securing plate and the old foil.
- Clean the window and place the new foil with the black side outwards.
- Square the foil in the window and remount the securing plate.
- Control and if necessary update the sensing foil coefficients according to the foil certificate, refer next chapter or Technical Note TN 275.
- Recalibrate the sensor.

Calibration

If the sensor foil has not been removed or changed recalibration is normally not necessary. Feedback from our users shows that the sensors (and foils) are stable for one to several years.

The easiest and fastest way for a user to calibrate the Oxygen Optode is to use OxyView Software, refer page 26. OxyView is a window based Software containing a wizard, which guides the user step by step through the calibration procedure.

The present chapter describes how to perform the calibration procedure without

using OxyView. A calibration primer which presents equations used by the oxygen sensor is given in Appendix 6

NOTE!

Losing power during the flashing process can cause corruption of vital settings, such as coefficients, serial number, model number etc. If losing power, contact Aanderaa Data Instruments for new setting file for the specific optode with further instructions.

Flashing is carried out when running the Do_CalAir, DO_CalZero, Do_Calibrate and Save commands.

Calibration Procedure using a terminal program

1. Prepare a suitable container with fresh water. Aerate (apply bubbling) the water using an ordinary aquarium pump together with an airstone, and let the temperature stabilize (might take hours).
2. Prepare a zero oxygen solution by dissolving 5 grams of sodium sulfite (Na₂SO₃) in 500 ml of water. Other substances that removes oxygen can also be used.

NOTE! Stripping of the oxygen with e.g. N₂ gas is also possible, but not recommended, since it is uncertain when an absolute zero Oxygen level is reached using this method.

3. Connect the sensor to a PC by use of the Sensor Cable 3855 (Figure A 12).

Start a terminal program, i.e. the HyperTerminal by Hilgraeve Inc (included in Microsoft operating systems), with the following set-up:

9600 Baud
 8 Data bits
 1 Stop bit
 No Parity
 Xon/Xoff Handshake

NOTE! Select one of the options 'Sent line ends with line feeds' or 'Echo line ends with line feeds' in the Hyper Terminal.

Control, and if necessary update, the C₀Coef, C₁Coef, C₂Coef, C₃Coef and C₄Coef properties accordingly to the Calibration Certificate for the sensing foil in use (refer CHAPTER 3 for communication with the sensor).

Example of changing foil coefficients:

```
Set_Protect(1)
Set_FoilNo(1403)
Set_C0Coef(3.95439E+03,-1.38606E+02,2.98835E+00,-2.73775E-02)
Set_C1Coef(-2.46937E+02,7.58489E+00,-1.62433E-01,1.50790E-03)
Set_C2Coef(6.32108E+00,-1.67391E-01,3.64539E-03,-3.50274E-05)
Set_C3Coef(-7.61504E-02,1.72586E-03,-3.95623E-05,4.02602E-07)
Set_C4Coef(3.52769E-04,-6.78062E-06,1.70524E-07,-1.86920E-09)
Save
```

Type *Get_All* to verify the new coefficients.

4. Submerge the optode into the aerated water. Set the *Interval* property to e.g. 30 seconds. Enter the *Save* command and wait until both the temperature and the phase measurements have stabilized:

```
Set_Protect(1)  
Set_Interval(30)  
Save
```

5. Store calibration values by typing:

```
Set_Protect(1)  
Do_CalAir
```

The *save* command is automatically performed when you type *Do_CalAir*.

6. Set the *CalAirPressure* property to the actual air pressure in hPa at the site.

```
Set_Protect(1)  
Set_CalAirPressure(..)  
Save
```

NOTE! For maximum accuracy do not compensate the air pressure for height above sea level.

7. Submerge the optode in the zero solution. Make sure that the sensing foil is free from air bubbles. Wait until both the temperature and the phase measurements have stabilized.
8. Enter the *Do_CalZero* command to store calibration values. The *save* command is automatically performed.

```
Set_Protect(1)  
Do_CalZero
```

9. Enter the *Do_Calibrate* command to effectuate the new calibration. The *save* command is automatically performed.

```
Set_Protect(1)  
Do_Calibrate
```

10. Check that the sensor is working properly by taking it up into the air and rinse off. In dry air, the sensor should show close to 100% oxygen saturation at sea level. Put the sensor back into the anoxic water; the reading should drop to zero.

Appendix 1 Theory of Operation

The Oxygen Optode is based on a principle called dynamic luminescence quenching.

This phenomenon is the ability of certain molecules to influence the fluorescence of other molecules. Fluorescence is the ability of a molecule to absorb light of a certain energy and later emit light with lower energy (longer wave length). Such a

molecule, called a luminophore, will after absorbing a photon with high enough energy, enter an excited state.

After a while the luminophore will emit a photon of lower energy and return to its initial state. Some types of luminophores might also return to the initial state when colliding with certain other molecules.

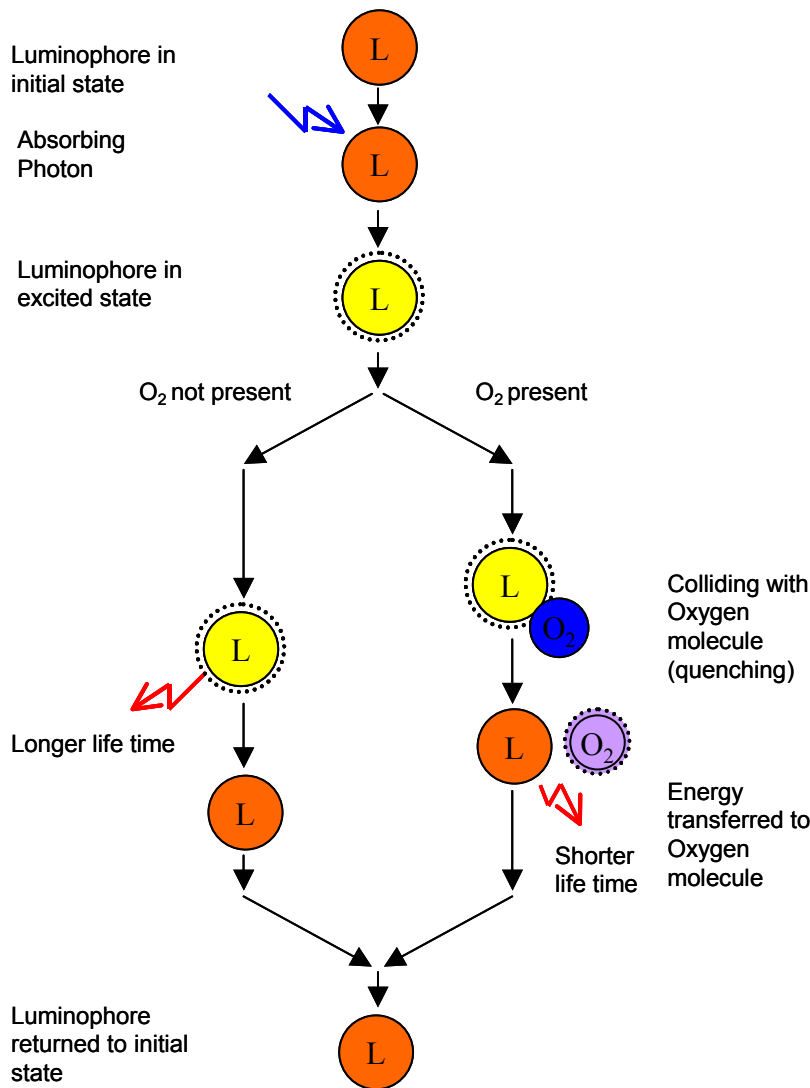

Figure A 1 Dynamic Luminescence Quenching

The luminophore will then transfer parts of its excitation energy to the colliding molecule, with the result that less photons (giving a shorter life time) are emitted from the luminophore. This effect is called dynamic luminescence quenching, and in the Oxygen Optode the colliding molecules are O₂.

The luminophore used in the Oxygen Optode is a special molecule called platinum porphyrine. These luminophores are

embedded in a polymer layer, called the indicator layer (coated on a thin film of polyester support).

To avoid potential influence from fluorescent material surrounding the sensor or direct incoming sunlight when measuring in the photic zone, the foil is also equipped with gas permeable coating.

The coating gives optical isolation between the indicator layer and the surroundings.

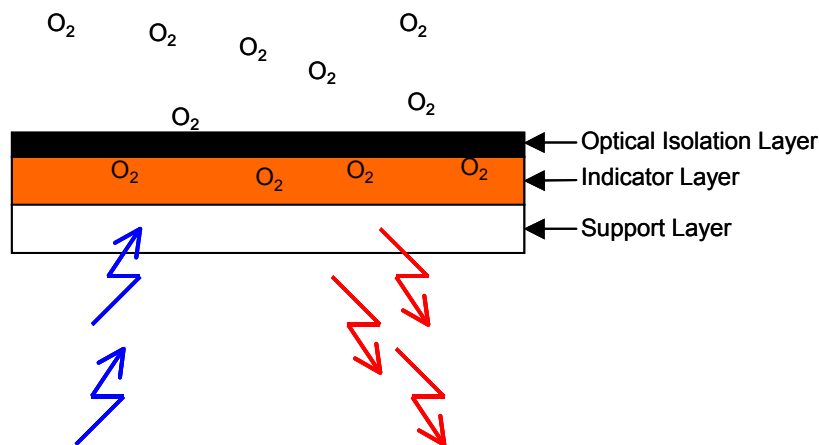

Figure A 2 Sensing Foil

Luminescence Decay Time

Due to its fluorescent behaviour the sensing foil will return a red light when it is excited with a blue-green light (505 nm). If there is O₂ present this fluorescent effect will be quenched.

The amount of returned light will therefore depend on the O₂-concentration in the foil.

The intensity of the returned light is however not the optimal property to measure since it depends on many other factors as i.e. optical coupling or bleaching of the foil.

Since the returned light is delayed with respect to the excitation light, the presence of O₂ will also influence the delay.

This property is called luminescence decay time (or lifetime) and it will decrease with increasing O₂-concentrations.

The relationship between the O₂-concentration and the luminescence decay time can be described by the Stern-Volmer equation:

$$[O_2] = \frac{1}{K_{SV}} \left\{ \frac{\tau_0}{\tau} - 1 \right\}$$

where:

τ = decay time

τ_0 = decay time in the absence of O₂

K_{SV} = Stern-Volmer constant (the quenching efficiency)

In order to measure this luminescence decay time, the sensing foil is excited with a blue-green light modulated at 5 kHz.

The decay time is a function of the phase of the received signal.

In the Oxygen Optode the relationship between the phase and the O₂-concentration is used directly, without calculating the decay time.

Figure A 3 shows a typical relationship between the phase measurement and O₂-concentration.

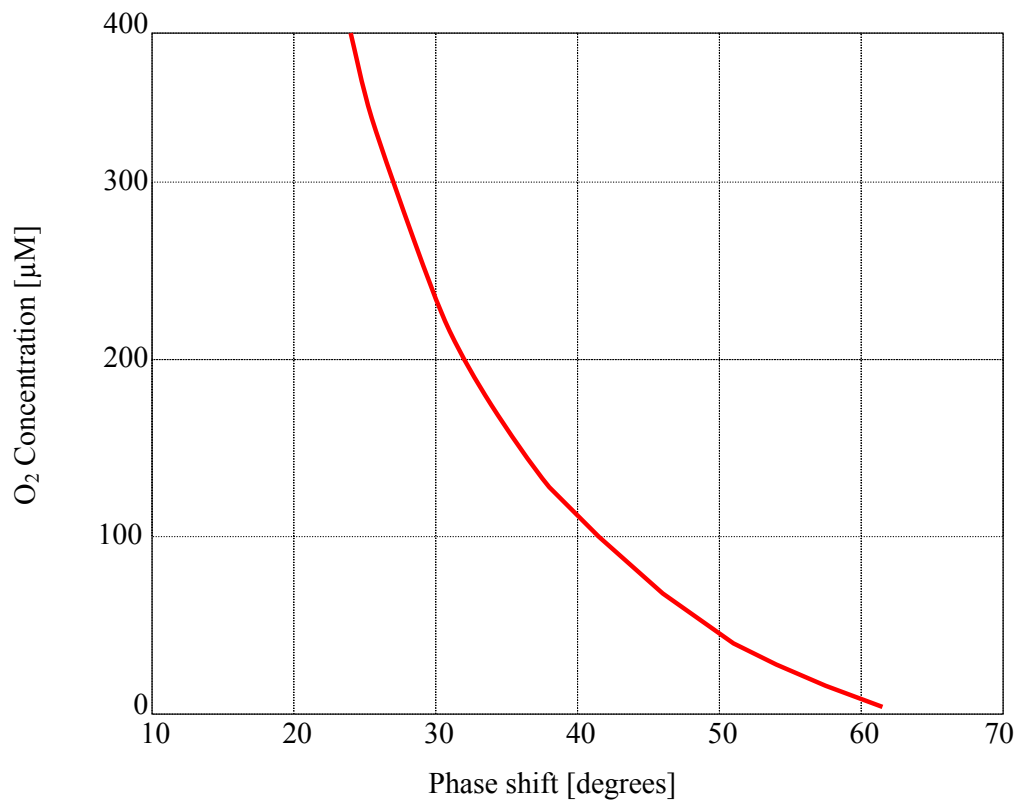

Figure A 3 Typical Phase/O₂ response

Appendix 2 The Optical Design

An illustration of the optical design is given in Figure A 4.

The sensing foil is mounted outside the optical window and is exposed to the surrounding water. The foil is held in place by a screw fixed PVC plate.

Two light emitting diodes (LEDs) and one photodiode is placed on the inside of the window. A blue-green LED is used for excitation of the foil. The photodiode is used for sensing the fluorescent light.

Even though the sensing foil is highly fluorescent part of the light will be directly reflected.

The photo diode is equipped with a colour filter that stops light with short wavelengths to minimize the influence of the reflected light. Further, the blue-green LED is equipped with a filter that stops light with long wavelengths.

In addition, a red 'reference' LED was included to compensate for potential drift in the electronics of the transmitter and receiver circuit.

As of today the red LED does not improve the sensor characteristics and is consequently not connected.

The spectral response of the LEDs and the filter are illustrated in Figure A 5.

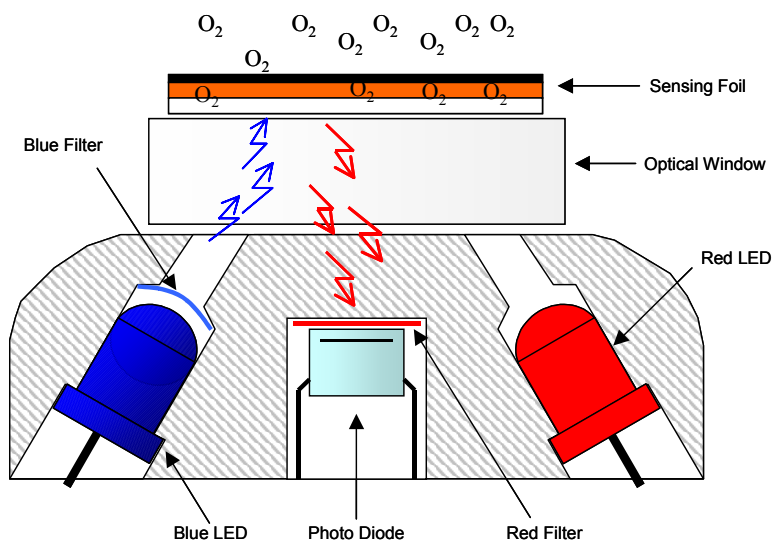

Figure A 4 The Optical Design

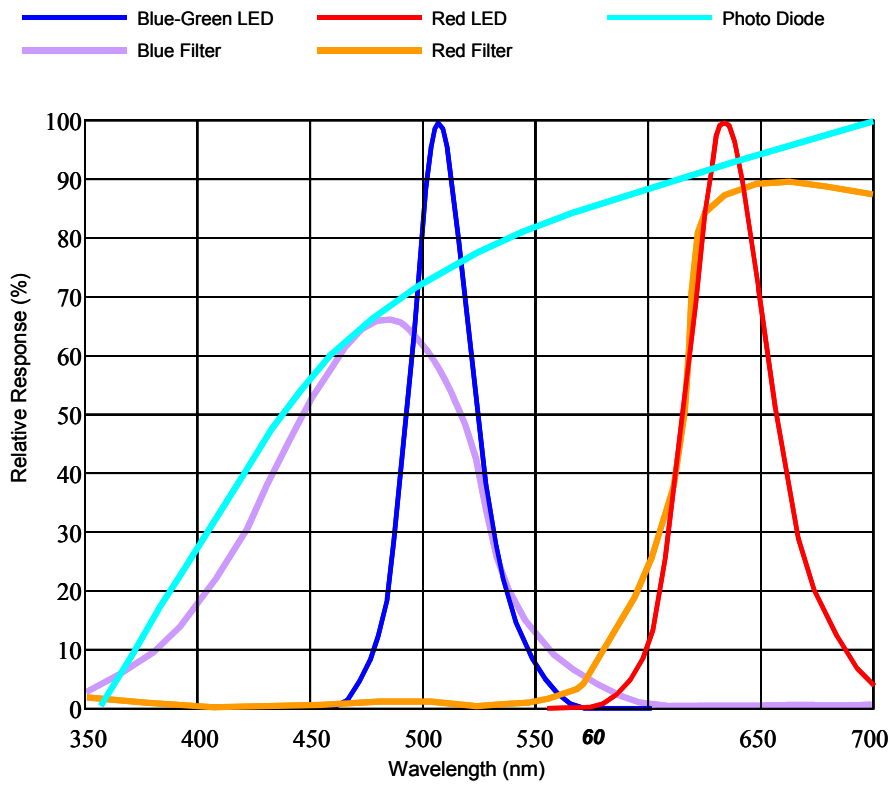

Figure A 5 An example of Spectral Response

Appendix 3 Electronic Design

Figure A 6 illustrates the main functions of the electronics.

To obtain good oxygen measurements the electronic circuit must be able to measure the phase between the excitation signal and the received signal accurately and with good resolution.

The received signal is sampled with a frequency of four times the excitation frequency. Two signal components with a

phase difference of 90 degrees are extracted from these samples and is used for calculations of the phase of the received signal.

The O₂-concentration is calculated after linearizing and temperature compensating the phase measurements.

A thermistor thermally connected to the sensor body, provides the temperature measurement.

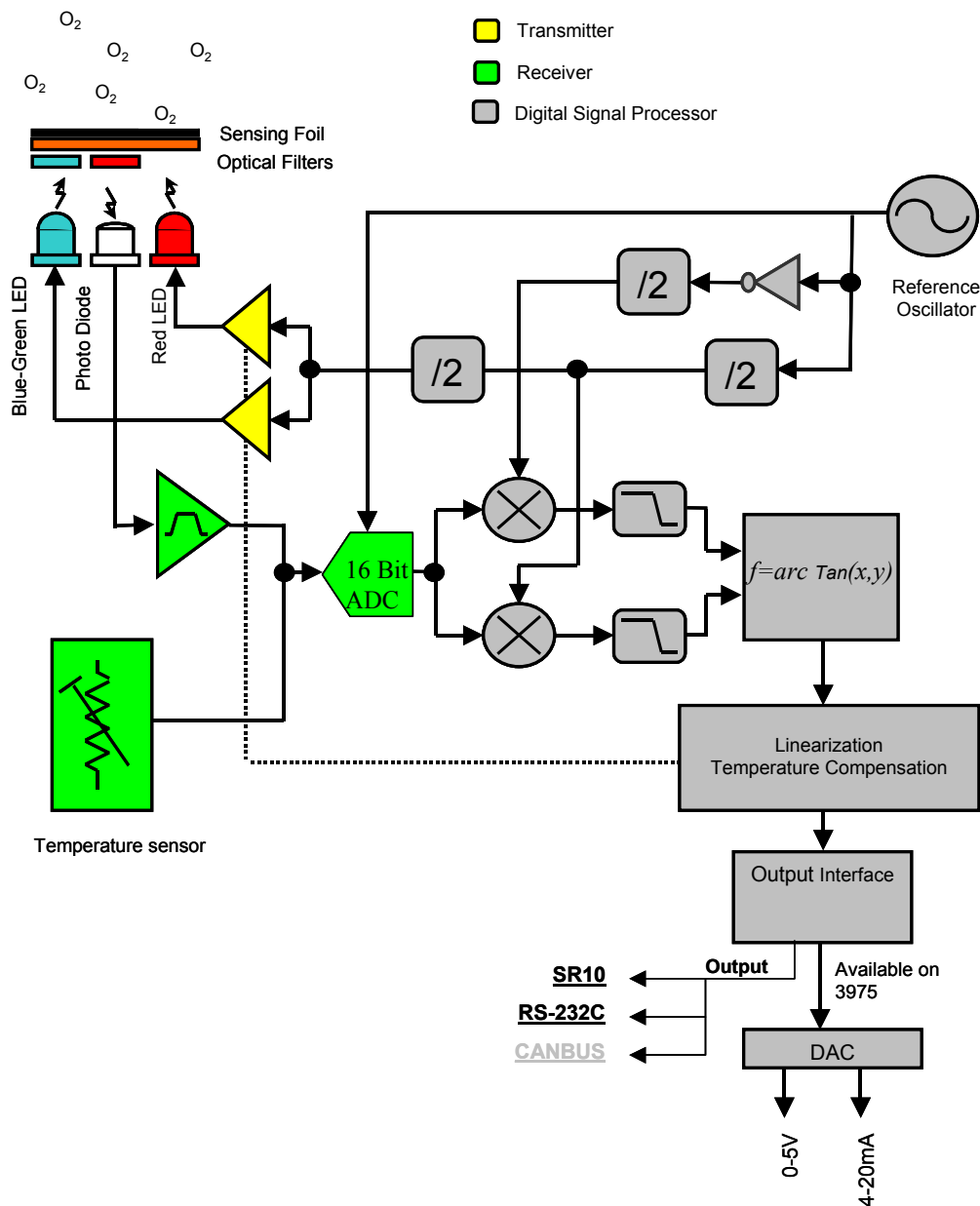

Figure A 6 Functional Diagram

Appendix 4 Mechanical Design

Refer Figure A 7 and Figure A 8 for illustration of the Oxygen Optode.

A cylindrical titanium housing shields the electronics from the surrounding water and high pressure.

A 4mm thick sapphire window provides the optical connection between the optics inside the optode and the sensing foil on the outside.

The foil is fixed to the window by a securing plate in PVC and is easily replaceable.

A 10-pin receptacle in the sensor foot provides all electrical connection to the sensor.

To prevent potential leakage from the sensor to the rest of the measurement system, the receptacle is first moulded inside a receptacle housing.

Refer CHAPTER 5 for instructions concerning changing the Sensing Foil.

Note! The sensor should not be opened! Opening the sensor housing can breach the warranty (ref. CHAPTER 5, page 35 for instructions on how to change the Sensing Foil).

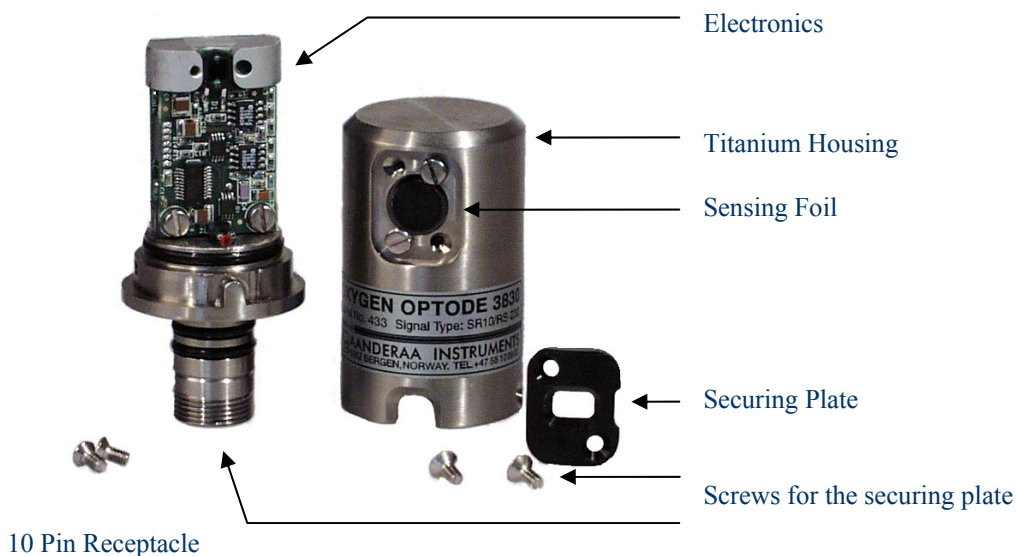

Figure A 7 Oxygen Optode components. *NOTE! The sensor housing should not be opened.*

Electrical Connections

Refer Figure A 12 for illustration of cables.

The 10-pin receptacle in the sensor foot mates with an Aanderaa 3216A plug on the top end plate of Aanderaa Current Meters/Profilers (RCM 9 MkII, RCM 11 and RDCP600). Use Sensor Cable 3854 between the top-end plate and the electronic board.

For connection between the optode and a PC the 1.5 meter Sensor Cable 3855 can be used. This cable has a watertight 10-pin plug to be connected to the sensor, and a 9 pin D-Sub plug to be connected to the PC serial port (RS232).

The additional USB plug is used for providing power to the sensor (the USB port normally gives 5V power).

Power may alternatively be connected to an included extension to the USB plug (5-14V).

NOTE!

By using a Cable Coupler 3472 and a standard Connecting Cable 3282 this connection can be extended up to 15 meters.

Maximum cable length for RS232 communication is 15 meters.

Maximum cable length for SR10 output is 400 meters.

The optodes pin configuration are given in Table A 1.

Table A 1 Pin Configuration

3830	3930	3975
1: Positive Supply ^{A), B)}	1: System Ground	1: Positive Supply
2: Ground ^{C)}	2: <i>Not Connected</i>	2: Ground
3: -9V ^{D)}	3: -9V	3: Analogue Output 1
4: Reserved, <i>Do Not Connect</i>	4: <i>Not Connected</i>	4: Return Ground 1
5: Bridge Voltage (BV)	5: Bridge Voltage (BV)	5: Analogue Output 2
6: Reserved, <i>Do Not Connect</i>	6: SR10 (Oxygen)	6: Return Ground 2
7: RXD (RS232)	7: <i>Not Connected</i>	7: RXD
8: TXD (RS232)	8: <i>Not Connected</i>	8: TXD
9: Control Voltage	9: Control Voltage	9: <i>Not Connected</i>
10: SR10 (Oxygen)	10: VR22 (Temperature)	10: <i>Not Connected</i>

- A) Ground for SR10
- B) Supply for RS232
- C) Ground for RS232
- D) Supply for SR10

Receptacle, exterior view; pin = ● , bushing = ○

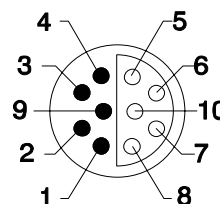

Appendix 5 Optode Specifications

Oxygen Optode 3830

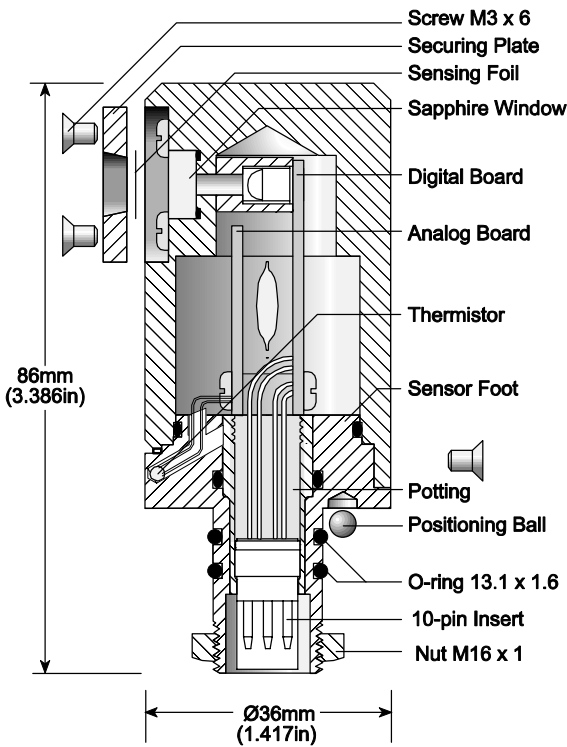

Figure A 8 Illustration of the Oxygen Optode 3830

Table A 2 Specifications for the Oxygen Optode 3830

		Channel1 Oxygen	
		O ₂ -Concentration	Air saturation
Measuring Range		0-500 µM ³	0 – 120%
Resolution		< 1 µM	0.4%
Accuracy		< 8 µM or 5% ⁴ whichever is greater	< 5% ⁴
Settling time (63%)		< 25 sec	
		Channel2 Temperature	
Range		0 to +36°C	
Resolution		0.01°C	
Accuracy		±0.05°C	
Settling time		<25 sec	
		General specifications	
Operating Temperature		0 to +40°C (32 to 104°F)	
Operating Depth		0 – 6000m (19,690 ft)	
Output Formats		Aanderaa SR10, RS232 ⁵	
Sampling rate		SR10: SR10 Controlled by the datalogger. RS232: From 1s to 255min	
Current Consumption		SR10: 10mA/T where T is recording interval in min RS232: 80mA/s +0.3mA where s is recording interval in sec	
Supply Voltage		SR10: -6 to -14 Vdc RS232: +5 to +14Vdc	
Dimensions		Ø36x86mm (Ø1.42x3.386in)	
Weight		230g (8.113oz)	
Materials		Titanium, Hostaform (POM)	
Warranty		Two years against faulty material and workmanship	
Accessories		Sensor Cable 3854	
Accessories included	not included	Sensor Cable 3855 to PC ⁶ Foil Service Kit 3853 PST ₃	

³ O₂-Concentration in µM = µmol/l. To obtain mg/l, divide by 31.25

⁴ Valid with pressure and salinity compensations, ref CHAPTER 4.

⁵ Terminal settings: 9600 Baud, 8 data bits, 1 stop bit, No Parity, Xon/Xoff Handshake

⁶ In order to change settings or calibrating the Optode the sensor must be connected to a PC, ref CHAPTER 3

Oxygen Optode 3930

The Oxygen/Temperature Optode 3930 consist of an Adaptor 3714 mounted to an Optode 3830. Refer Figure A 8 for illustration of the Oxygen Optode 3830. An illustration of the Adaptor 3714 is given in Figure A 9.

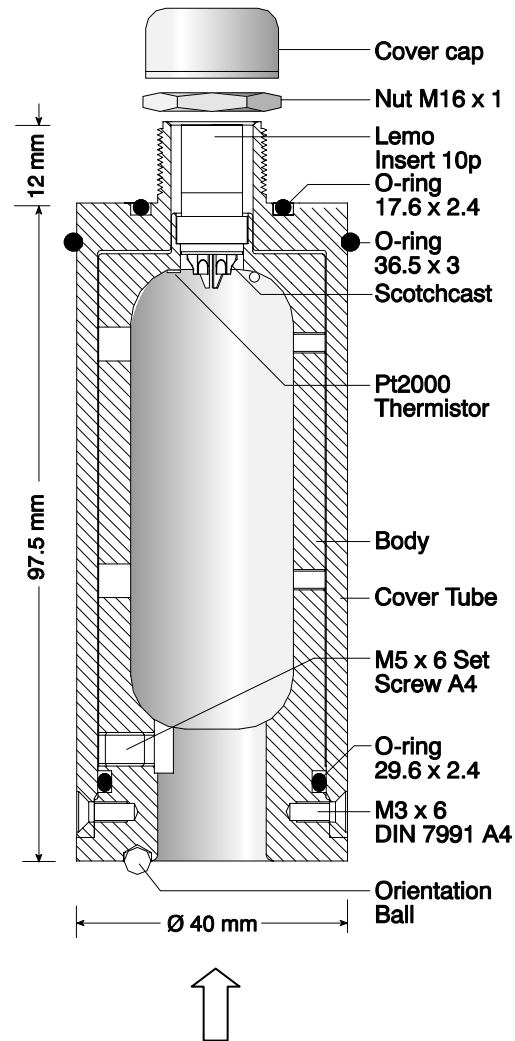

Connection for Optode 3830

Table A 3 Specifications for the Oxygen/Temperature Optode 3930

	Channel1 Oxygen	
	O ₂ -Concentration	Air saturation
Measuring Range	0-500 μM ⁷	0 – 120%
Resolution	< 1 μM	0.4%
Accuracy	< 8 μM or 5% ⁸ whichever is greater	< 5% ⁴
Settling time (63%)	< 25 sec	
	Channel2 Temperature	
Range	-7.5 to +41°C	
Resolution	0.05°C	
Accuracy	±0.1°C	
Settling time	30 sec	
	General specifications	
Operating Temperature	0 to +40°C (32 to 104°F)	
Operating Depth	0 – 1000m (3,280 ft)	
Output Formats	Aanderaa SR10 ⁹ (Oxygen), VR22 ⁵ (Temperature)	
Sampling rate	Controlled by the datalogger	
Current Consumption	10mA/T where T is recording interval in min	
Supply Voltage	SR10: -6 to -14 Vdc	
Dimensions	Ø40x168mm (OD1.575x6.61in)	
Weight	495g (17.5oz)	
Materials	Titanium, Hostaform (POM)	
Warranty	Two years against faulty material and workmanship	
Accessories not included	Sensor Cable 3855 to PC ¹⁰ Foil Service Kit 3853 PST ₃	

Figure A 9 Illustration of Adaptor 3714

⁷ O₂-Concentration in μM = μmol/l. To obtain mg/l, divide by 31.25

⁸ Valid with pressure and salinity compensations, ref CHAPTER 4.

⁹ Aanderaa SR10/VR22 are signals protocols that are used with Aanderaa equipment only

¹⁰ In order to change settings or calibrating the Optode the sensor must be connected to a PC, ref CHAPTER 3

Oxygen Optode 3975

The Oxygen Optode 3975 consist of an Adaptor 3966 mounted to an Optode 3830. Refer Figure A 8 for illustration of the Oxygen Optode 3830. An illustration of the Adaptor 3966 is given in Figure A 10.

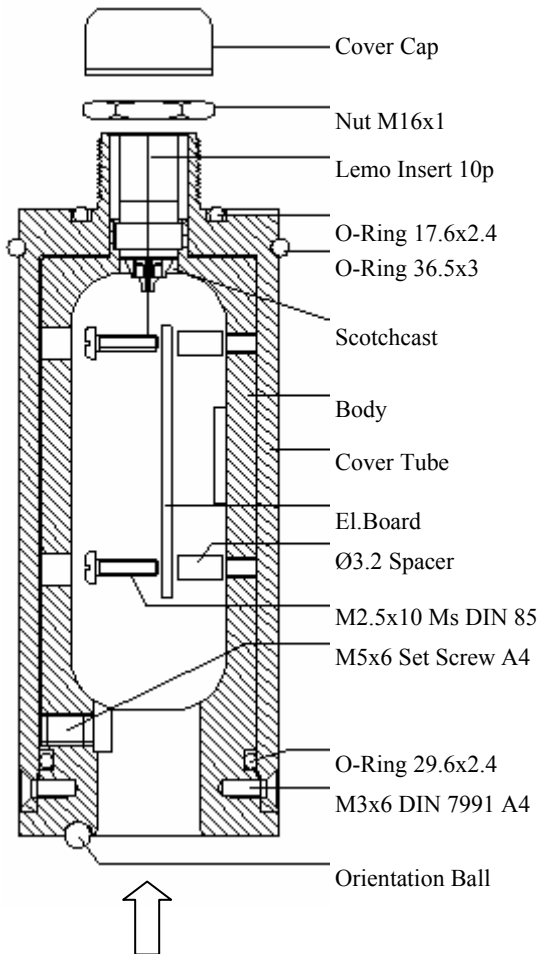

Connection for Optode 3830

Figure A 10 Illustration of Adaptor 3966

Table A 4 Specifications for the Oxygen Optode 3975

		Channel1 Oxygen	
		O ₂ -Concentration	Air saturation
Measuring Range		0-500 µM ¹¹	0 – 120%
Resolution		< 1 µM	0.4%
Accuracy		< 8 µM or 5% ¹² whichever is greater	< 5% ⁴
Settling time (63%)		< 25 sec	
		Channel2 Temperature	
Range		0 to +36°C	
Resolution		0.01°C (0-5V) / 0.02°C (4-20mA)	
Accuracy		± 0.1°C (0-5V) / ± 0.15°C (4-20mA)	
Settling time		30 sec	
		General specifications	
Operating Temperature		0 to +40°C (32 to 104°F)	
Operating Depth		0 – 6000m (19,690 ft)	
Output Formats		0-5V output: ± 0.1% of FS ¹³ 4-20mA output: ± 0.2% of FS ⁵ RS232 ¹⁴	
Sampling rate		From 1s to 255min	
Current Consumption		80mA/s +0.3mA + I _a where s is recording interval in sec and I _a is quiescent: 5 to 45mA when analogue adaptor is enabled	
Supply Voltage		Analogue: -6 to -14 Vdc RS232: +5 to +14Vdc	
Dimensions		Ø40x175.5mm (Ø1.42x6.9in)	
Weight		480g (16.93oz)	
Materials		Titanium, Hostaform (POM)	
Warranty		Two years against faulty material and workmanship	
Accessories included	not	Sensor Cable 3855 to PC ¹⁵ Foil Service Kit 3853 PST ₃	

¹¹ O₂-Concentration in µM = µmol/l. To obtain mg/l, divide by 31.25

¹² Valid with pressure and salinity compensations, ref CHAPTER 4.

¹³ The accuracy in 0-5V output mode is specified to 0.1% of FS. At the end of the scale (<0.0-0.07> and <4.93-5.0>) the error may be larger

¹⁴ Terminal settings: 9600 Baud, 8 data bits, 1 stop bit, No Parity, Xon/Xoff Handshake

¹⁵ In order to change settings or calibrating the Optode the sensor must be connected to a PC, ref CHAPTER 3

Appendix 6 Calibration Procedure -Primer

Each batch of sensing foils is delivered with calibration data describing the behaviour with respect to oxygen concentration and temperature. When changing the sensing foil the following 20 coefficients must be updated:

$C0Coef_{0..3}$

$C1Coef_{0..3}$

$C2Coef_{0..3}$

$C3Coef_{0..3}$

$C4Coef_{0..3}$

These coefficients are found in the Calibration Certificate for the Sensing Foil 3853, refer enclosed documentation. Refer page 35 for changing foil coefficients.

In addition to the above mentioned coefficient update a two point calibration must be done. This calibration compensates for individual sensor and foil variations.

NOTE! In order to ease this calibration procedure, the following calculation is performed inside the sensor. See "Calibration Procedure using a terminal program" in CHAPTER 5 or use the OxyView calibration wizard (refer CHAPTER 3).

Two controlled oxygen concentrations are relatively easy to obtain, one in air saturated water, and one in a zero-oxygen solution.

An air-saturated solution is obtained by inserting freshwater in a glass and bubble it with a standard aquarium pump. For a more efficient bubbling it is recommended to use a bubble dispenser. The water should be allowed to achieve temperature stability for at least 1 hour. We recommend the zero oxygen solution to be obtained by preparing

P_{C0} = calibrated phase at zero oxygen

another glass of the same water (as for air saturation) and dissolving 5g of sodium sulphite (Na_2SO_3) in 500ml water.

When measuring in vapour-saturated air the sensor will respond equal to measuring in air-saturated fresh water. The O_2 -concentration will in this case be given by the following equation:

$$[O_2] = \left(\frac{p - p_v(t)}{1013} \right) \cdot \frac{100 \cdot R_{O_2}}{V_m} \cdot \alpha(t)$$

where:

p = atmospheric pressure in hPa

t = temperature, °C

$p_v(t)$ = vapour pressure in hPa

$$\approx e^{\left(\frac{52.57 - \frac{6690.9}{t+273.15} - 4.681 \cdot \ln(t+273.15)}{t+273.15} \right)}$$

α = Bunsen absorption coefficient

$$\approx 48.998 - 1.335t + 2.755 \cdot 10^{-2} t^2 - 3.22 \cdot 10^{-4} t^3 + 1.598 \cdot 10^{-6} t^4$$

R_{O_2} = 20.95 % = volume percentage of O_2

V_m = 22.414 l/mol = molar volume of O_2

Solving for the square roots in the equation for $[O_2]$ and $[O]$ gives the ideal phase measurement at zero and 100% oxygen:

$$[O_2]_{100} = C_0 + C_1 P_{C1} + C_2 P_{C1}^2 + C_3 P_{C1}^3 + C_4 P_{C1}^4$$

$$[O_2]_0 = C_0 + C_1 P_{C0} + C_2 P_{C0}^2 + C_3 P_{C0}^3 + C_4 P_{C0}^4$$

where:

P_{C1} = calibrated phase in air saturated water

$[O_2]$ = oxygen concentration in air saturated water

C_0, \dots, C_4 are temperature dependent coefficients calculated from:

$$C_x = C_{x0} + C_{x1}t + C_{x2}t^2 + C_{x3}t^3$$

t = the temperature, °C

C_{x0}, \dots, C_{x3} coefficients are stored respectively in the C_0Coef_{0-3} to C_4Coef_{0-3} property.

A calibrated phase measurement P_c (DPhase) is calculated as a 3rd degree polynomial of the uncalibrated phase measurement P :

$$P_c = A + BP + CP^2 + DP^3$$

The uncalibrated phase measurement is the difference between the phase obtained with blue light excitation (BPhase) and the phase obtained with red light excitation (RPhase).

Note! The red light excitation will normally not be used and RPhase is then set to zero.

The coefficients A, B, C and D in the above polynomial are stored in the property (setting) called *PhaseCoef*. From the two point calibration only the first two (1 degree) coefficients are calculated (C, D = 0). These two coefficients of the *PhaseCoef* (A and B) can be calculated by ordinary linear curve fitting:

$$B = \frac{P_{c1} - P_{c0}}{P_1 - P_0} \quad A = P_{c0} - \left(\frac{P_{c1} - P_{c0}}{P_1 - P_0} \right) P_0$$

where:

P_0 = uncalibrated phase measurement calibration at zero oxygen

P_{c0} = calibrated phase measurement calibration at zero oxygen

P_1 = uncalibrated phase measurement calibration in air

P_{c1} = calibrated phase measurement calibration in air

The *Do_Calibrate* command starts a function that calculates and stores the above coefficients based on the following properties:

CalAirPhase: Uncalibrated phase measurement at calibration point in air bubble solution.

CalAirTemp: Temperature measurement in °C at calibration point in air bubble solution.

CalAirPressure: Air pressure in hPa at calibration point.

CalZeroPhase: Uncalibrated phase measurement at calibration point in zero solution.

CalZeroTemp: Temperature measurement in °C at calibration point in zero solution.

These properties may be entered manually or by use of the *Do_AirCal* and the *Do_ZeroCal* commands.

When the readings have stabilized in air the *Do_AirCal* command can be entered to sample and store values in the *CalAirTemp* and *CalAirPressure* property.

Likewise, the *Do_ZeroCal* command is used for sampling and storing value to the *CalZeroPhase* and *CalZeroTemp* property after stabilization in the zero solution.

A subsequent execution of the *Do_Calibrate* command effectuates a new calibration.

Appendix 7 Improve Accuracy of the Oxygen Optode 3975 (1-4V)

Introduction:

A digital to analogue adaptor will induce a slightly poorer accuracy. Before a sensor outputs a digital value, the output value is modified by the following equation:

$$D_{out} = a_0 + a_1 D$$

where D_{out} is the digital value set out by the sensor, D is the digital value calculated e.g. on the basis of the current temperature measurement and a_0 , a_1 are coefficients. As default, $a_0 = 0.0$ and $a_1 = 1.0$, so that $D_{out} = D$.

By measuring the zero-code-error and the gain-error, new coefficients can be calculated and higher accuracy than $\pm 0.1\%$ of FS can be obtained. The coefficients are modified by means of the *Set_AnCoef*(a_0 , a_1) command.

NOTE! Most user will find the accuracy in the 3975 optode satisfactory.

Illustration:

The solid line in Figure A 11 shows the output from an ideal Digital to Analogue Converter (DAC); if the digital input is zero, the analogue output is also zero and if the digital input is 65536 (for a 16 bits DAC) the analogue output is 5 volt. The dotted line shows the actual output due to zero-code error and gain error.

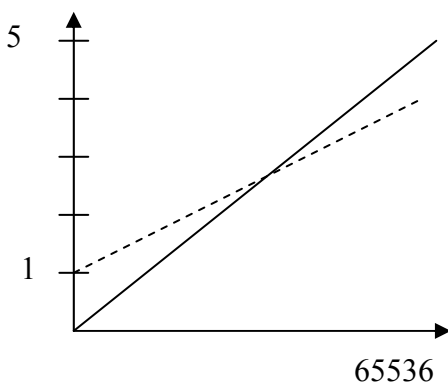

Figure A 11 DAQ output

Procedure:

NOTE! Refer CHAPTER 3 for communication with the sensor before performing this correction!

Connect the Optode to the PC via Hyper Terminal or OxyView Software.

Measure the output signal on Output 1 (connect a Voltmeter over pin 3 and 4) in sensor mode -111 for 1 Volt setting at channel 1. Type:

Set_Protect(1)

Set_Output(-111)

Save

Write down the Voltmeter reading: X_{11} .

Measure the output signal on Output 2 (connect a Voltmeter over pin 5 and 6) in sensor mode -110 for 1 Volt setting at channel 2. Type:

Set_Protect(1)

Set_Output(-110)

Save

Write down the Voltmeter reading, X_{21} .

Calculate the a_0 coefficient by:

$$a_0 = \left(1.0 - \frac{(x_{11} + x_{21})}{2} \right) \cdot 2^{16}$$

Store a_0 in the oxygen optode by typing:

Set_Protect(1)

Set_AnCoef(a_0 , 1.0)

Save

Repeat this procedure for measurements of X_{11} , X_{12} , X_{22} , X_{21} for 4 V setting at channel 1 and channel 2:

Sensor Mode	Output 1	Output 2
-111	X ₁₁	X ₂₂
-110	X ₁₂	X ₂₁

Store the coefficients in the oxygen optode by typing:

Set_Protect(1)

Set_AnCoeff(a₀, a₁)

Save

Calculate the a_1 coefficient by:

$$a_1 = \frac{(4.0 - 1.0)}{\left(\left(\frac{(x_{12} + x_{22})}{2} \right) - \left(\frac{(x_{11} + x_{21})}{2} \right) \right)}$$

Appendix 8 Calculate the Oxygen Externally

If the Optode is mounted on a CTD and the CTD is equipped with a fast responding temperature sensor it might be desirable to do the temperature compensation externally. This will improve the accuracy when subjected to fast temperature changes (when going through a gradient). The Optode must then be configured to output differential phase shift information (DPhase). Based on this data and the temperature data from the CTD, the oxygen concentration can be calculated by use of the following formula:

$$[O_2] = C0Coef + C1Coef \cdot P + C2Coef \cdot P^2 + C3Coef \cdot P^3 + C4Coef \cdot P^4$$

P is the measured phase shift (DPhase) and the $C0Coef$ to $C4Coef$ are temperature dependent coefficients calculated as:

$$CxCoef = CxCoef_0 + CxCoef_1 \cdot t + CxCoef_2 \cdot t^2 + CxCoef_3 \cdot t^3$$

The $CxCoef_{0-3}$ are the foil characterizing coefficients found in the Calibration Certificate for the Sensing Foil 3853, and t is external temperature in °C.

An Excel sheet that includes these calculations is available by contacting the factory.

If the CTD is not able to receive the RS232 output, the Oxygen Optode 3975 with analogue output can be used. The two channel “intelligent” digital to analogue converter supplied with this sensor is able to output two channels of your selection (including DPhase). By setting the Output property to -103 the Optode 3975 will output phase (10 to 70°) at analogue output 1 (refer to Table 3-4 at page 23).

Appendix 9 Illustrations

Figure no.	Description
Figure A 12	Illustration of some cables
Figure A 13	Drawing Cable 3854
Figure A 14	Drawing Cable 3855
Figure A 16	Drawing Cable 3296
Figure A 17	A 17 Drawing Cable 3485
Figure A 18	Drawing Cable 3976
Figure A 19	Drawing Cable 3980

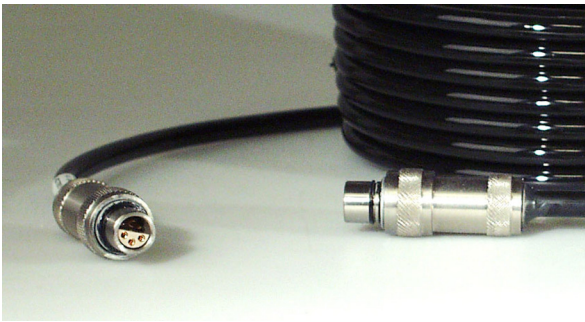

3296. Connecting cable 10 pin to 6 pin (1000m depth capability).

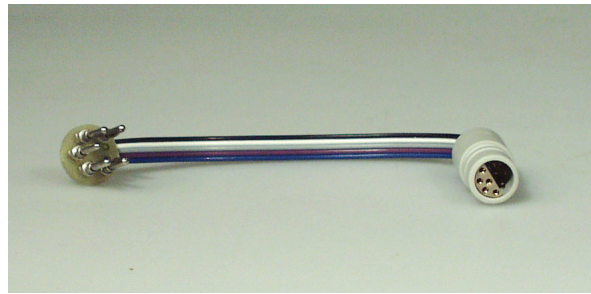

3854. Connecting cable 10 pin to Cell Plug. Used with Aanderaa Current Meters.

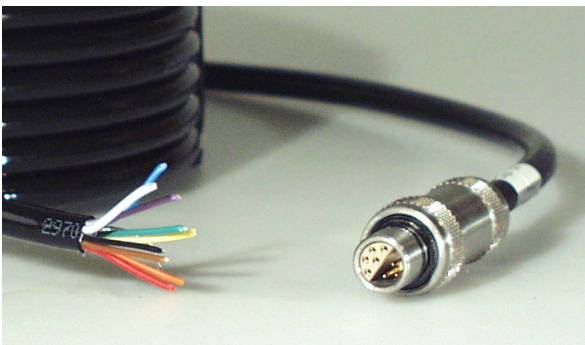

3485. Connecting cable 10 pin to free end (1000m depth capability).

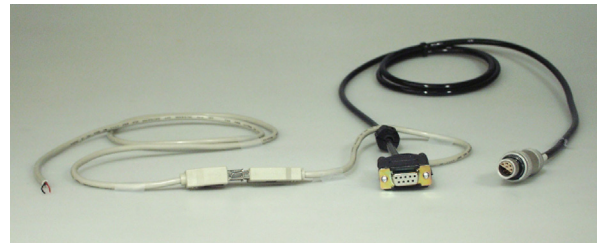

3855. Connecting cable for PC. *NOTE! The connector is made in aluminium and is not recommended for long term use in salt water.*

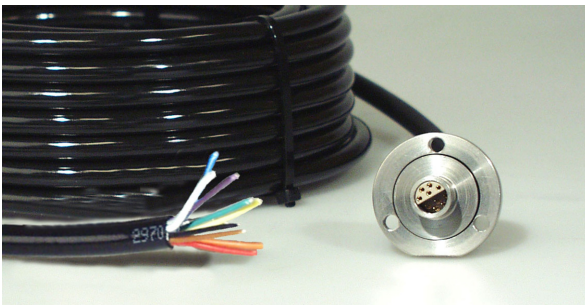

3976¹⁶. Flange connecting cable 10 pin to free end (6000m depth capability).



3980¹⁶ Flange connecting cable 10 pin to 10 pin (1000m depth capability).

Figure A 12 Illustration of some cables

¹⁶ Used with coupling 3979 for 36mm sensors and coupling 3977 for 40mm sensors.

V-8699

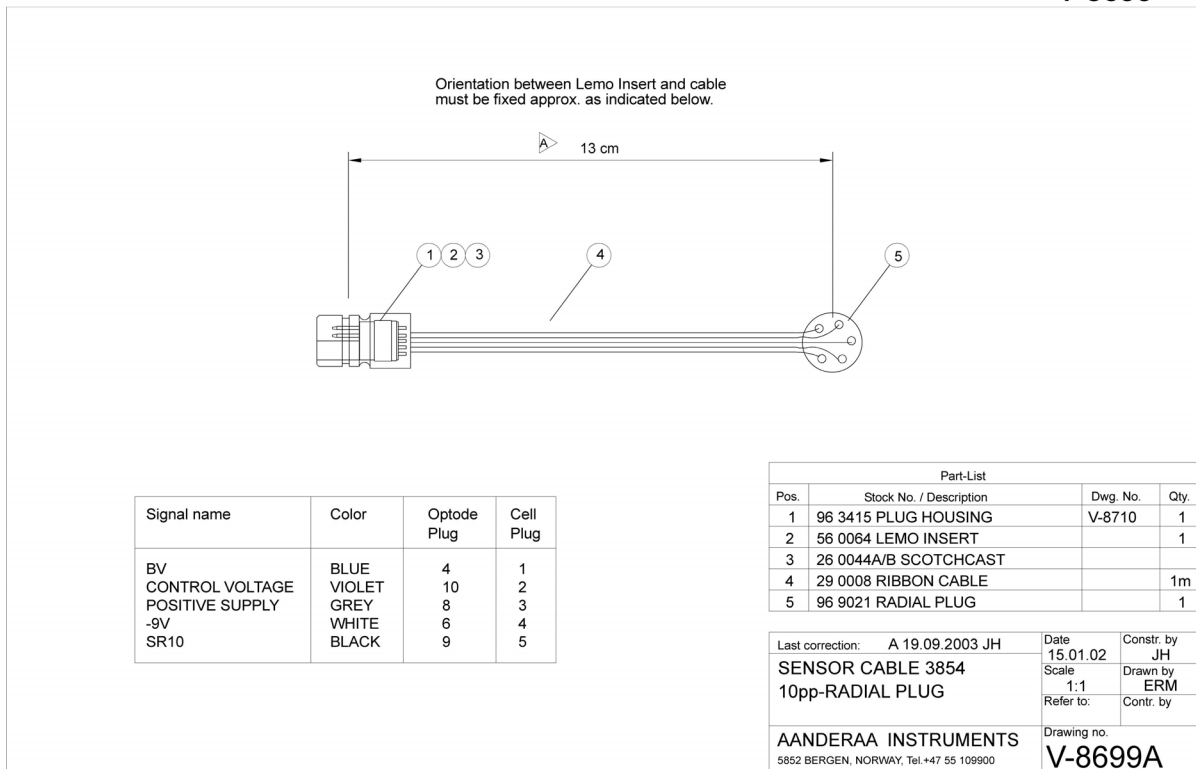

Figure A 13 Drawing Cable 3854

V-8700

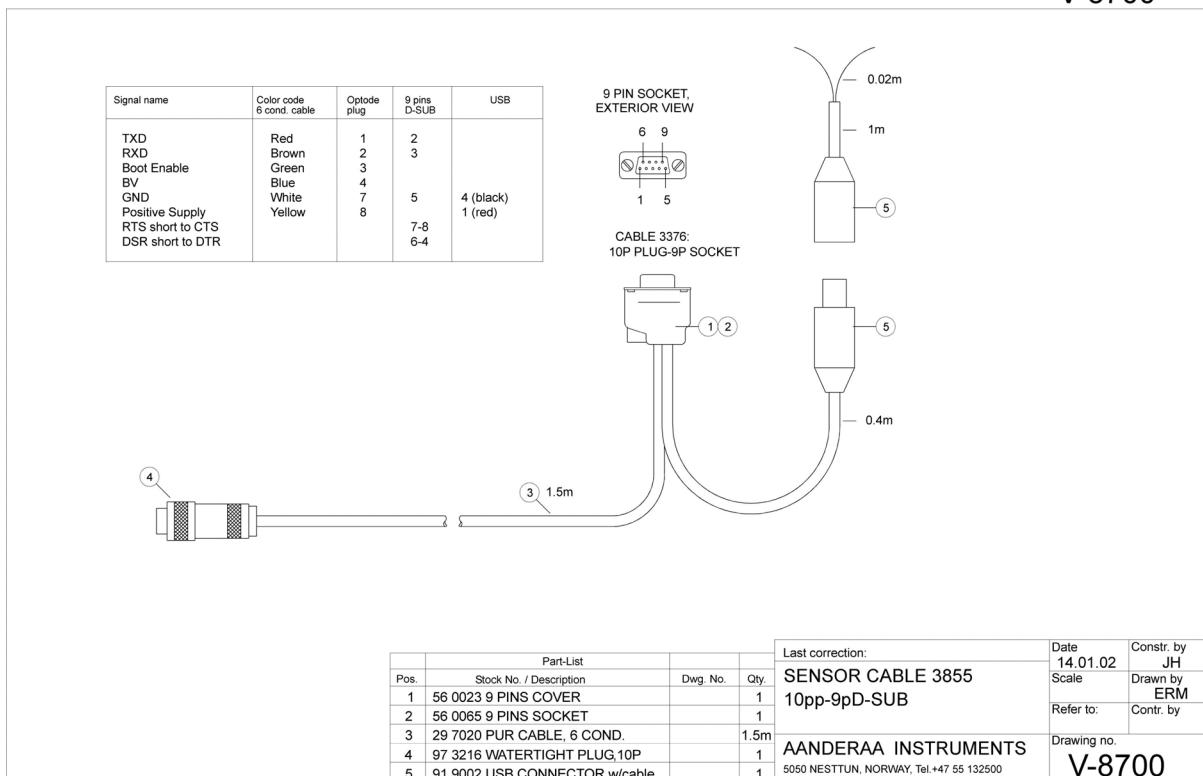

Figure A 14 Drawing Cable 3855

S-6507

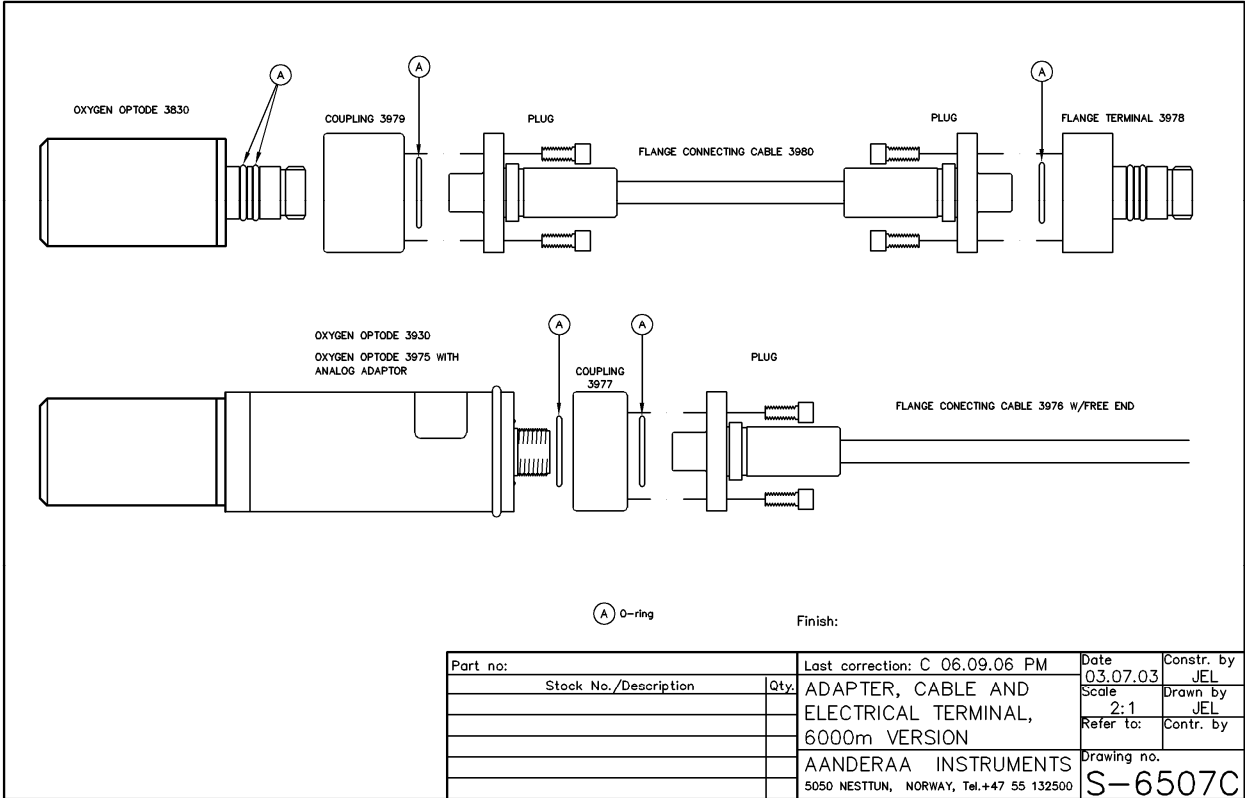

Figure A 15 Assembly drawing of cable connection for deepwater version (1000-6000 m)

V-6288

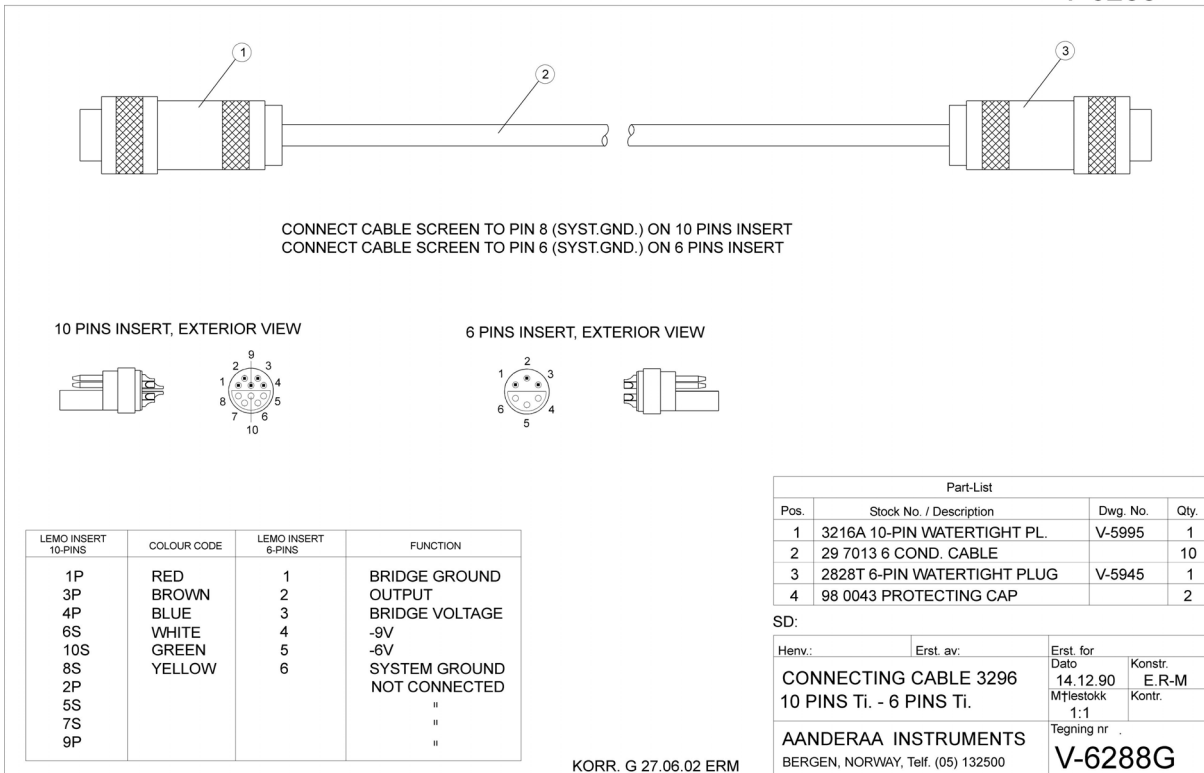

Figure A 16 Drawing Cable 3296 (0-1000 m)

V-9402

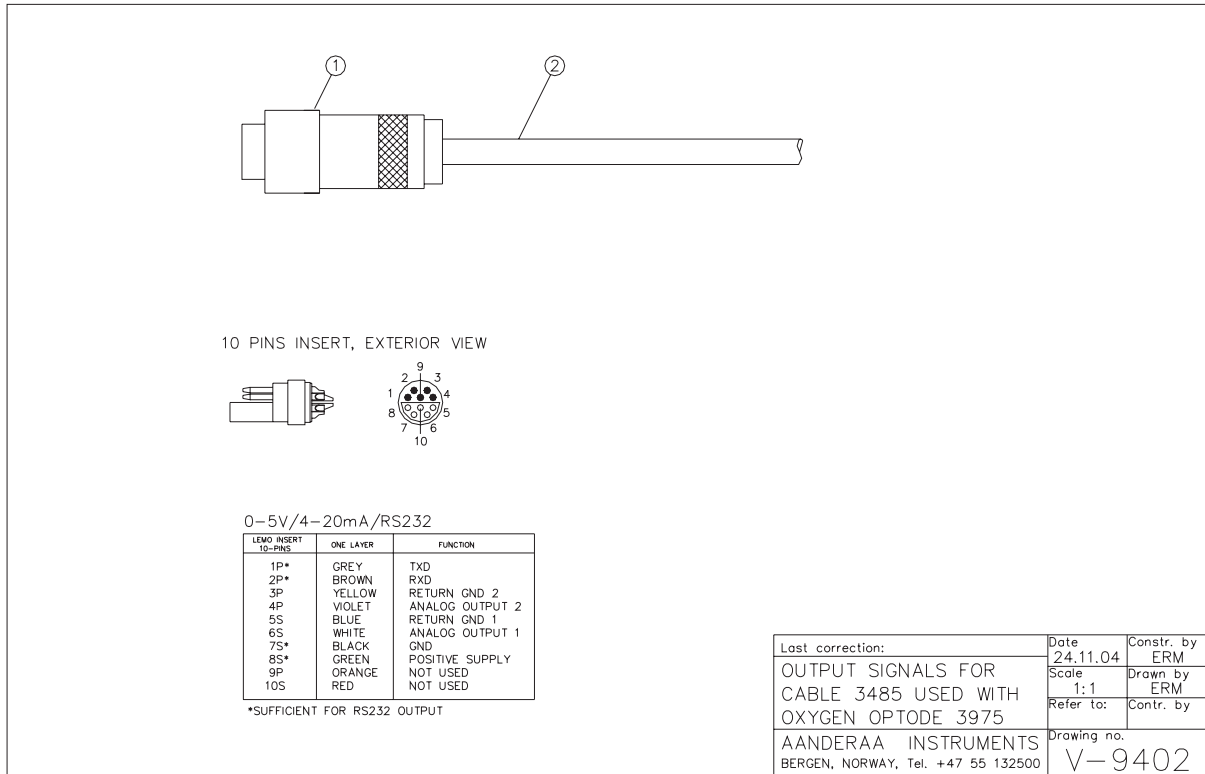

Figure A 17 Drawing Cable 3485 (0-1000 m)

V-9171

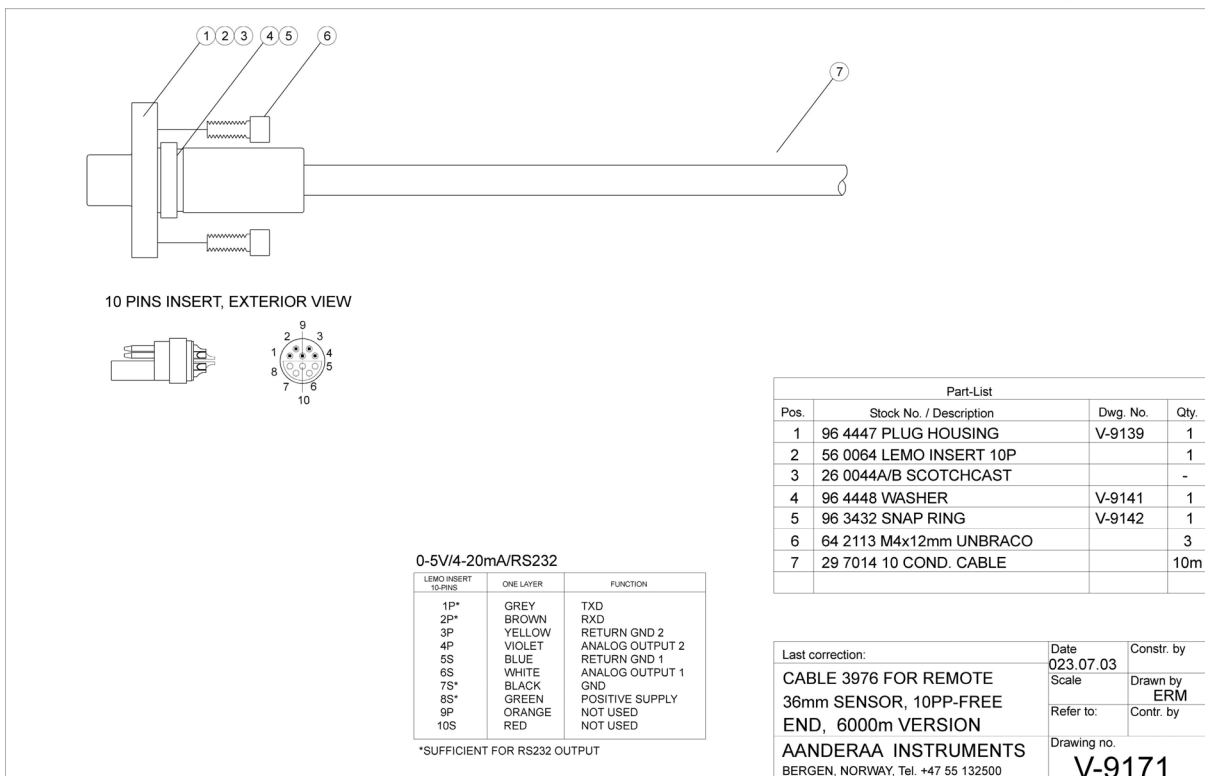

Figure A 18 Drawing Cable 3976 (1000-6000 m)

V-9151

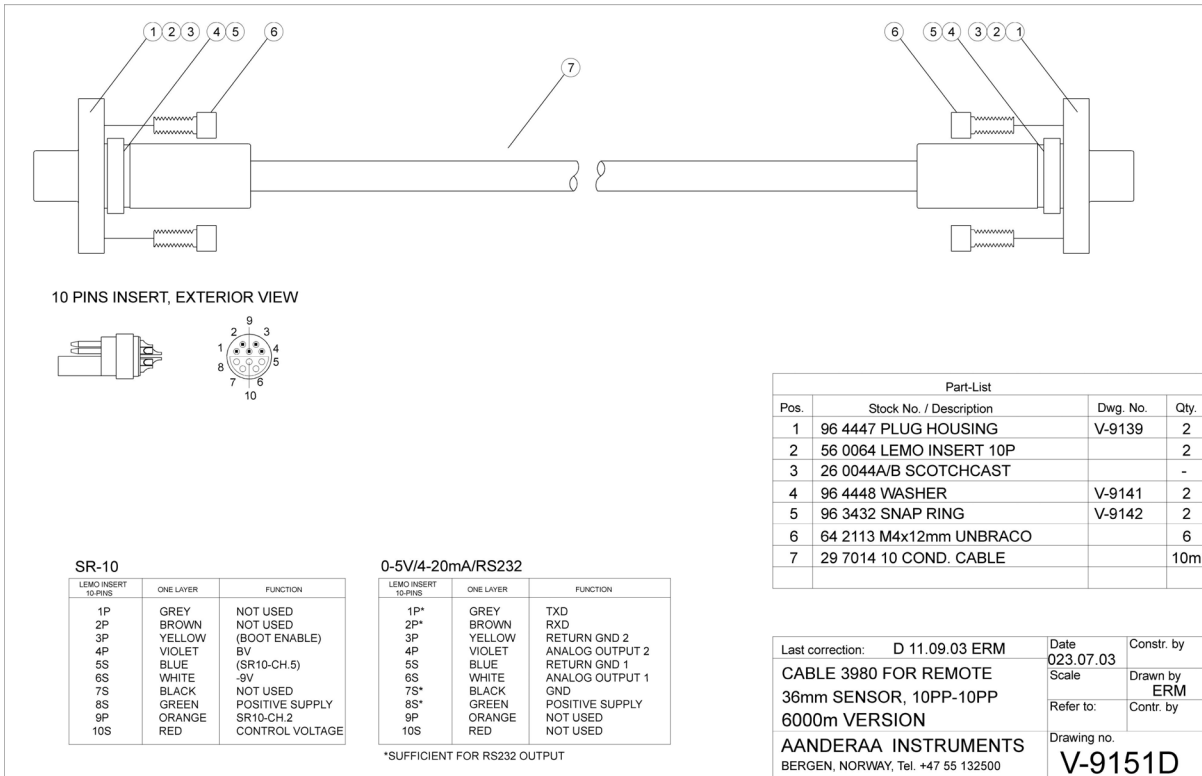

Figure A 19 Drawing Cable 3980 (1000-6000 m)

Appendix 10 Frequently Asked Questions -FAQ

In this chapter we present a copy of our FAQ for the optodes. The latest version is on our web site, refer <http://www.aanderaa.com/>

Calibration, Calibration Coefficients, Accuracy and Precision

CCAP1

Q: What calibration coefficients are used in the sensor, how can I make sure that I use the correct ones?

A: The sensor has several sets of calibration constants stored in its memory.

These can be verified from your PC via the OxyView software or with a terminal communication program.

The coefficients are:

1. The internal temperature sensor has its own calibration constants that can not and do not need to be changed by the user.
2. The sensing foil has a set of 20 constants C_0 to C_4 (in a 5 x 4 matrix), which are specific to that batch of foils (normally produced in batches of 100). If you change the foil with a foil from a different batch you must update the foil constants stored in the sensor with a set of new constants by entering them manually into the sensor.
These constants are delivered on a calibration certificate together with the new foil.
3. The sensor and the foil has a set of calibration constants (called phase coefficients) that are obtained and automatically stored in the sensor when a two point calibration is performed, using a 100% air saturated solution and 0% oxygen solution.
When changing or removing the foil a new calibration must be performed to obtain accuracy and precision.
The most efficient way to do this calibration is to use the OxyView software.
4. When data from the sensor is registered on an Aanderaa data-logger (e.g. on a RCM 9, a buoy etc.) the Aanderaa specific SR10 format is used.
These readings then need to be post-processed (converted to the desired engineering units) by multiplying with a constant.
This constant is obtained by dividing the range by the 10-bit resolution of the SR10 format.
If you have selected to output oxygen concentration in μM in the SR10 format you will have to multiply the obtained data by 0.488281.
If you select to output % saturation you will have to multiply with 0.146484.

CCAP2

Q: If I change the foil and forget to update the internal constants but I made a new calibration can I back-calculate to get the correct data?

A: If the foil is from the same batch it will have the same constants and the data should be ok.

If the foil is not from the same batch it will not be possible to post-compensate the obtained data.

It is imperative to use the correct foil constants and to do a new two-point calibration if the foil has been changed or moved.

CCAP3

Q: It appears as if the specifications for accuracy and precision of the sensor are conservative compared to its actual performance, why?

A: After calibration the sensors normally perform better than the given specifications. Aanderaa has a tradition to be conservative when giving sensor specifications so that these reflect the “worst situation” performance in the field.

CCAP4

Q: Can the accuracy of the sensor be further improved?

A: Yes, if the individual sensor was calibrated in more calibration points (e.g. 30 point calibration), both with respect to oxygen concentration and temperature compensation of the foil, the accuracy would be improved by approximately a factor of 4.

However, this means an increase in the production cost and requires the sensor to be sent back to the factory for recalibration if the foil is changed after delivery.

Some customers that need particularly high accuracy have established their own calibration procedures.

CCAP5

Q: How often do I need to re-calibrate the sensor?

A: If the foil is not mechanically damaged or moved no recalibrations are needed within the time of one year.

We recommend a recalibration once a year but from field experiences we see that the sensor is stable over much longer time periods than this.

For investigators that have experience with electrochemical sensors it might be tempting to make frequent foil changes and recalibrations but this is not needed.

When you receive the sensor from the factory no calibrations are needed but of course you should check that it is working properly.

CCAP6

Q. The brochure says accuracy of 8µM or 5% (whichever is greater).

Does this mean that at very low levels the accuracy is 5% of the measurement?

A: No, this means that the accuracy is 8µM for readings below 160µM and 5% for readings above 160µM.

CCAP7

Q: Is there a minimum measuring point or will the sensor go all the way down to zero?

A: It will go all the way to 0. There is no minimal measuring point.

CCAP8

Q: When calibrating, which substance should I use to remove the oxygen in the water?

A: At Aanderaa we use Sodium sulfite for this purpose.

Sodium sulfite rapidly removes the oxygen and as long as crystals of the compound can be seen the oxygen level in the water will stay at 0. Sodium sulfite also has the advantage of being inexpensive and the level of toxicity is low.

There are many other chemical substances that could be used for the purpose.

Some investigators use Sodiumdithionit, which is also effective but more expensive and more toxic.

Bubbling with gases (e.g. N₂, Argon etc) will also “strip off” the oxygen from the water but this takes longer time and sometimes, especially if the water volume is large, it can be difficult to know when a true zero oxygen level has been reached.

CCAP9

Q: When calibrating at saturation, which type of device should I use to get 100% saturation?

A: It is advisable to use standard aquarium equipment, which is normally inexpensive. An aquarium pump connected to a tube which has been fitted with porous stone (bubble dispenser) at the end is suitable.

This will create small air bubbles that are efficient in equilibrating the water rapidly.

Be careful with using compressed air or compressor/vacuum type pumps since these are likely to compress the air/oxygen which will give errors when calibrating.

Normally the sensor will under-read after such a calibration.

A similar situation will occur if the sensor is calibrated in a “deeper” water tank.

If the air bubbling and the sensor are placed at for example at 1 m water depth the over pressure will be approximately 10%.

CCAP10

Q: When calibrating which type of vials/containers should be used?

A: It is preferable to use clean glass vials, instead of plastic, for calibrations and any types of experiments.

There have been examples in which oxygen has either been consumed by substances bound into the plastic container walls or oxygen has diffused through the walls from the outside.

Glass is preferable for basically all applications that are dealing with dissolved gases.

CCAP11

Q: When sampling the sensors at high frequencies (1-10 s intervals) there appears to be some self heating of the sensor.

What can be done to minimize the effects of the self heating and how big is the effect of it?

A: The sensor has linear power regulators which means that if you supply it with higher voltage (e.g. 8-14V) it will still consume the same amount of Amperes as at 5V.

The additional energy at higher voltages will be lost as heating which will contribute to the self heating.

Therefore it is better to supply the sensor with 5V in high sampling frequency applications.

Laboratory testing at 5V has revealed that self heating of the sensor can introduce a 1 μ M (giving lower readings than correct) when sampled at a 1 second sample-interval.

This error drops to 0.2 μ M for a 5 second interval. The error of the internal temperature sensor at a 5 s sampling interval is approximately 0.03°C. At a 1 s sampling interval it is approximately 0.1°C. Care should be taken when using the sensor in on-line system applications.

The internal temperature sensor is placed in the “foot” of the sensor. If mounting the sensor in the wall of an on-line system that has high thermal conductivity (e.g. metal walls) with the outside this might give significant effects on the optode temperature sensor, which also will lead to errors in the oxygen readings since these temperature readings are used for the necessary temperature compensation.

CCAP 12

Q: I am measuring in the laboratory and the sensors are oscillating regularly with an amplitude of a couple of μ M.

The oscillations decrease when I immerse the sensors into air saturated water but they are still detectable.

What is the reason for these oscillations?

A. The response of the sensors are directly affected by changes in air pressure.

If you are working in a laboratory which is equipped with an automatic climate control system the ventilation will most likely be turned on and off at regular intervals.

The operation of the ventilation will create air pressure changes in the room which are sensed by the optodes.

It is important to think about this especially if you are calibrating sensors.

You have to take into account the local air pressure and if this is not the same inside your

laboratory as at the air pressure you enter during calibration it will introduce errors.

CCAP 13

Q: Is there a difference in the sensor response if the foil is wet or dry?

A: Yes the sensor is and should be calibrated in a wet environment and it takes hours for the foil to become completely wet or dry.

Taking a sensor which has been sitting in a dry environment for several hours and introducing it into water to make a spot measurement can lead to an error of maximum 2%.

Keeping the sensor in a humid environment for at least 12 h will eliminate this error.

If you would like to do spot measurements, where the sensor is out of the water most of the time, we recommend you to keep the sensor in a wet environment (such as a plastic bag with water) in-between measurements.

Measurement Related

MR 1

Q: Can I measure oxygen in air with the sensor?

A: Yes, but in dry air you should expect slightly higher readings since there is no water vapor present.

The space normally taken by vapor in humid air is here replaced by more air and consequently the sensor should give slightly higher readings.

Please be aware that there is a high risk of having a different temperature at the foil compared to the temperature of the incorporated temperature sensor in air.

This might lead to errors in the temperature compensation and to readings that are not correct.

MR 2

Q: What is the reason that several sensors plunged into the same water do not give exactly the same values?

A: From experience we know that at occasions when this question was raised the user had not mixed the water well and consequently the oxygen concentrations were different at different locations in the water bath.

Due to the simple two point calibration (see above) differences (within specifications) between sensors should be expected.

It has happened that customers that want a higher accuracy have developed their own calibration procedures.

This can improve the accuracy significantly (see above).

MR 3

Q: What physical factors will affect the sensor?

A: Temperature (which is already internally compensated), salinity (see below or Operating Manual) and pressure (see below or Operating Manual).

The two latter parameters are easily compensated for by simple formulas which are common for all sensors.

MR 4

Q: What chemical factors/elements will affect the sensor?

A: There exists no cross sensitivity for carbon dioxide (CO₂), hydrogen sulfide (H₂S), ammonia

(NH₃), pH, any ionic species like sulfide (S₂⁻), sulfate (SO₄²⁻) or chloride (Cl⁻).

The sensors can also be used in methanol- and ethanol -water mixtures as well as in pure methanol and ethanol.

It should not be used in other organic solvents, such as acetone, chloroform or methylene chloride, which may swell the foil matrix and destroy it.

Interferences (cross-sensitivity) are found for gaseous sulfur dioxide (SO₂) and gaseous chlorine (Cl₂).

MR 5

Q: Is the sensor sensitive to H₂S?

A: No, it is not. It will not be damaged by H₂S and it is not cross-sensitive to it.

If H₂S is present the oxygen concentration should be zero or very close to zero since O₂ and H₂S rarely coexists, especially over longer time periods.

MR 6

Q: What is the pressure behavior of the sensor?

A: The pressure effect is that the sensor reads 4% lower readings/1000 meters of water depth which means that at 1000 meters you will have to multiply your readings with 1.04 to get the correct absolute values and at 2000 meters with 1.08 etc.

This effect is the same for every sensor, it is linear and fully instantaneously reversible, when the pressure is released.

MR 7

Q: What about hysteresis?

A: As opposed to electrochemical sensors this optode does not suffer from hysteresis.

The pressure effect on the sensor described above immediately disappears when the pressure is released.

A recent publication in which the optode was compared with an electrochemical sensor is found at our web site.

MR 8

Q: Can I log data of oxygen concentration, oxygen saturation and temperature simultaneously on the SR10 output (e.g. on a RCM9/RCM11/Buoy etc.).

A: No, the Optode only has one SR-10 output channel.

You can either select to log oxygen concentration or oxygen saturation on your instrument.

To see how this set-up is done see the Operating Manual or the OxyView software.

If you also would like to log the Optode's internal temperature sensor you will have to order the Oxygen Optode model 3930 which can output the temperature in parallel in VR22 format.

Note this is normally not necessary as our recording instruments include a separate temperature sensor.

MR 9

Q: Why is the sensor limited to a range of 0-120% and 0-500 μM?

A: These limitations are only present when logging the sensor in SR10 or analog formats.

If logging the sensor in RS232 or CAN bus there are no upper limits for the measurements range.

However the user should be aware of the sensors and the foils are only calibrated to 500μM beyond these limits a lower accuracy and precision should be expected.

The 120% saturation limit is given for extreme conditions, which will rarely occur in reality.

At 0°C at a salinity of 0 ppt the 100% saturation reading of water is 457μM.

It is unlikely that in such waters there would be supersaturation since there is normally no or low primary production in water that is freezing.

Sea water (35 ppt) at 0°C contains 358μM at 100% saturation so here there is margin of up to 140% before the sensor reaches the SR10 measuring limit of 500μM.

To conclude the limitation when logging the sensor in SR10 or analog format is $500\mu\text{M} = 16\text{mg/l}$ the corresponding saturation limitations in % can be calculated when the temperatures and salinities are known.

MR 10

Q: How fouling sensitive is the sensor?

A: The sensor does not consume any oxygen and it is not stirring sensitive therefore it is less sensitive to fouling than electrochemical sensors.

The fouling sensitivity varies from case to case.

In the marine environment with high fouling conditions an unprotected Optode will give accurate readings as long as the fouling is not changing the local oxygen conditions around the sensing foil.

Some user experiences have shown that this, in the worst cases, can start to occur already after one week in warm and highly productive waters.

Previously a copper plate was used to mount the sensing foil with.

This solution offered improvements only in areas with important water circulation around the sensor.

In other applications it resulted in faulty readings and this solution has been discarded.

MR 11

Q: For how long time can you run the sensor before it will not work anymore?

A: The most critical limitation for the operational time (foil life) is foil bleaching.

When excited for a long time with strong blue light the foil will bleach and eventually reach a stage where the amplitude of the returning signal (even if it is lifetime based) will be too weak to be registered.

Laboratory tests at 2-second intervals have shown that the sensor can measure more than a year with this interval setting.

This means that the sensors can for example be operated for 5 years at a 10-second interval without any amplitude effects.

Exposure to direct sunlight will also excite/bleach the foil over time however this effect is minimal with the protection provided by the opaque/optical isolation layer.

MR 12

Q: Can the 3830 sensor be used down to full ocean depth just by connecting it to a standard titanium connector from Aanderaa?

A: No, for high pressures, beyond 100 bar, the Cable Adapter 3979 and Flange Connecting Cable 3976 should be used.

These are pressure rated to 600 bar. Please look in the Operating Manual or contact Aanderaa for more information.

MR 13

Q: Can I use the sensor for long-term measurements, in for example an on-line system, just by connecting it to a PC with the PC communication cable (model # 3855) that was delivered with the sensor?

A: Yes and No. It is not a problem to connect and log the sensor like this but you should be aware that the connector on the cable is made out of anodized Aluminium that will start to corrode when it is used for to long times in salt water.

The sensor is of Titanium and will not corrode. For long-term applications you should use a Titanium connector. Please ask Aanderaa for more information.

MR 14

Q: The Aanderaa Optode and/or software appear to be programmed to only report percent saturation relative to sea level.

How is it intended to take into account the barometric pressure, i.e., elevation, in reporting percent saturation?

A: External calculation and post-processing must be used for calculating “real” saturation with respect to barometric/water pressure.

The Optode’s internal software has not been prepared for measurements at high altitudes.

MR 15

Q: How high operation and storage temperature can the sensor stand?

A: Operating 0 to 40°C; Transport -40°C to 70°C, for storage we recommend room temperature or lower.

MR 16

Q: After calibration the maximum reading we can get in air at room temperature is 94.1 instead of 100. Do we need to replace the oxygen sensing foil?

A: The relative oxygen computed by the optode is referred to standard atmospheric air pressure (1013.25 hPa).

The lower reading of 94.1 most likely means that your measurement is taken in an environment where the air pressure is lower than standard air pressure.

See also question MR1.

You can find more about this topic in the operating manual.

MR 17

Q: Is there a difference in the sensor response if the foil is wet or dry?

A. Yes the sensor is and should be calibrated in a wet environment and it takes hours for the foil to become completely wet or dry.

Taking a sensor which has been sitting in a dry environment for several hours and introducing it into water to make a spot measurement measurements can lead to an error of maximum 2%.

Keeping the sensor in a humid environment for at least 12 hours will eliminate this error.

If you would like to do spot measurements, where the sensor is out of the water most of the time, we recommend you to keep the sensor in a wet environment (such as a plastic bag with water) in-between measurements.

MR 18

Q. I have mounted my sensors in chambers.

When I immerge them into the water the response increases dramatically and already at 10m water depth I am measuring about twice the concentrations compared to what I am measuring at the surface.

What is happening?

A. The most likely explanation is that you have trapped air inside your chambers and that the sensors are measuring in this air.

At 10m water depth the partial pressure of oxygen is two times higher and this is what you are measuring.

MR 19

Q. I have mounted my sensors in chambers to make sediment-water incubations at the bottom.

The oxygen readings looks normal until the chambers are inserted into the sediment and the lids are closed.

Then it looks like, from the response of the optodes, as if the oxygen concentrations increase.

What can the explanation be to this?

A. The most likely explanation is that you have trapped air inside your chambers and when you close the lid it dissolves and change concentration in the now sealed chamber.

The effect becomes particularly visible if you are working in environments with low ambient oxygen concentrations.

To avoid this ventilate your chamber for several hours before closing the lid. Then the air bubbles will dissolve.

MR 20

Q: I am measuring in the laboratory and the sensors are oscillating regularly with an amplitude of a couple of μM .

The oscillations decrease when I immerse the sensors into air saturated water but they are still detectable.

What is the reason for these oscillations?

A. The response of the sensors are directly affected by changes in air pressure.

If you are working in a laboratory which is equipped with an automatic climate control system the ventilation will most likely be turned on and off at regular intervals.

The operation of the ventilation will create air pressure changes in the room which are sensed by the optodes.

It is important to think about this especially if you are calibrating sensors.

You have to take into account the local air pressure and if this is not the same inside your laboratory as at the air pressure you enter during calibration it will introduce errors.

MR 21

Q: How do I convert oxygen data logged by the optode to other units?

A: The optode measures and presents data in micromole dissolved oxygen per liter ($\mu\text{mol/l}$). This unit is often also called micromolar (μM). Depending on the background and tradition of the user converting into other units might be useful.

To convert into mg/l the obtained values have to be divided by 31.25. To obtain ml/l the obtained values have to be divided by 44.66. To obtain $\mu\text{m/kg}$ the density of the water has to be calculated from temperature, salinity and pressure values that are measured in parallel with the oxygen.

For more specific information about this subject please look in: Methods of Seawater Analysis, 3rd Edition (1999). Klaus Grasshoff (Editor), Klaus Kremling (Editor), Manfred Ehrhardt (Editor). ISBN: 3-527-29589-5. Wiley.

MR 22

Q: What is the use of the phase, amp and rawTemp data in the long RS232 data format when using the Optode in stand alone mode?

Is there any diagnostic value in these data that would suggest foil aging, thermistor failure or otherwise indicate Optode service is required?

A: The initial reason for including these data as an option was mainly to have the possibility to quality check the internal calculations. For most users these data have no value and could be “turned off”.

The comprehensive string of raw data can be limited to oxygen concentration, oxygen saturation and temperature by setting the output to 0 (zero). This can be done either by using the OxyView software or by transferring a three line command string using any terminal program (please refer to the manual). However, for investigators that are using the optode on a fast profiling CTD it is recommended to use the CTD’s fast responding temperature sensor to temperature compensate the oxygen readings.

To do this the DPhase values have to be registered. For more specific information about how this is done please look at SSC13 in this FAQ and in the manual.

MR 23

Q: Why is salinity compensation needed?

A: As other oxygen sensors the Aanderaa optodes are measuring the level of oxygen saturation (partial pressure) in the water and not the absolute concentrations. To get the absolute

concentrations, the salinity has to be measured in parallel/known and compensated for. This can be done either internally by setting the salinity to a fixed value or externally by applying the formulas of Garcia and Gordon.

As a default value the internal salinity is set to 0 when optodes are delivered from the factory. This setting can be changed by using the OxyView software or a standard terminal program (please see the operation manual for more information). The formulas from Garcia and Gordon (1992) that can be used to post compensate the measured values are also given in the optode operation manual.

MR 24

Q: How does the air pressure influence the O₂ concentration?

A: If the air pressure is high (good weather or created by a ventilation system which gives over pressure) more oxygen can dissolve. For example if the air pressure is 1030 mbar compared to 990 mbar the saturation level will be $1030/990=4\%$ higher.

MR 25

Q: How does the salinity and temperature influence the O₂ concentration?

A: If the salinity and temperature are high, less oxygen can dissolve compared to if the salinity and temperature are low. For example: at 1000 mbar air pressure, a temperature of 20°C and a salinity of 35 ppt (typical for sea water) the water will reach an equilibrium concentration of 231 µM. At the same air pressure and temperature but at a salinity of 0 ppt (e.g. tap water) the saturation concentration will be 284µM.

Because the dissolution of a real gas does not follow the common gas law exactly, these concentrations are calculated with empirical formulas. Formulas that are frequently used (also by Aanderaa) are presented in: Garcia and Gordon (1992) Oxygen solubility in seawater: Better fitting equations. *Limnol. Oceanogr.* 37:1307-1312.

A link to Unisense AS tables for solubility of oxygen in seawater is given [here](#).

MR 26

Q: What is influencing the O₂ concentration in water?

A: If a glass of water is left in a room with constant temperature and constant air-pressure, oxygen in the air will dissolve in the water according to the common gas law. After some time a saturation equilibrium will be reached where no more oxygen can be dissolved in the water. If the water is stirred it will reach saturation faster.

How much oxygen that can be dissolved in the water is dependent on the salinity and temperature of the water and on the air pressure in the room.

A link to Unisense AS tables for solubility of oxygen in seawater is given [here](#).

MR 27

Q: Does the sensor react to changes in salinity?

A: No, The sensor does not react to changes in salinity.

This can be verified by having two glasses of air-bubbled water, at the same temperature, next to each other.

One filled with freshwater (0 ppt) and the other with saltwater (e.g. 35 ppt).

When moving the sensor from one glass to the other it should read the same absolute oxygen concentration, in µM, even though the absolute oxygen solubility in the salt water is lower.

MR 28

Q: Does the % saturation level change with the salinity compensation?

A: No, the % saturation level should be the same.

MR 29

Q: I'm going to have a deployment in ocean water with constant salinity (35 ppt). Is it possible to preset the internal setting in the sensor, to avoid post calibration?

A: Yes, this can be done. The default internal salinity is set to zero. If changing the internal salinity setting in the sensor (preferably using the OxyView software) to the correct value the sensor should give the correct absolute saturation concentration in the salt water.

This means that when working in waters with a constant and known salinity this value can be entered into the sensor prior to deployment.

Mechanical and Maintenance

MM 1

Q: How do I clean the foil after a deployment if it has been fouled?

A: In all cases the cleaning procedure should be done with caution so that the protective foil coating is not removed.

If the fouling is calcareous it can normally be dissolved with household vinegar (essig in German, eddik in Norwegian).

Another substance that can be used is commercially called muriatic acid, which is a 5% HCl solution (dilute solution by 50% should be tested to see how well it dissolves growth before using a stronger concentration).

If needed, the remains use Q-tips to gently wipe it off after it has been softened by soaking in vinegar/HCl. Optode can be submerged in vinegar/HCl over night, or longer.

If the marine growth

After cleaning the sensor it should be rinsed well in clean tap water before storing or reuse.

Do not use any organic solvents such as: Acetone, Chloroform and Toluene since these and others will damage the foil.

MM 2

Q: My foil has been damaged so that I can see scratches in the black protective layer and some blue light is coming out when measuring.

Do I need to change the foil?

A: No, normally not.

Even if quite heavily damaged the foil continues to work, in most cases.

As long as enough of the fluorophore remains on the foil the sensor will measure correctly.

If heavily damaged it is however recommended to recalibrate the sensor (with a standard two point calibration, see Operating Manual or OxyView software).

If the sensor behaves normally when placed in an air-bubbled water solution (showing 100 % saturation) the foil should be ok.

If the foil is not ok the sensor will return values that are illogical to what should be expected.

Then the foil needs to be exchanged, new calibration constants entered and a new two point calibration performed.

Remember that the Optode sensors can also be operated with transparent foils so the black protective layer is not essential.

If using a transparent foil it should then be noted that blue light will be spread out into the water. This might induce primary production if measuring at a frequent time interval without moving the sensor.

MM 3

Q: I have an old RCM7/RCM8, can I mount the Optode and log it with this instrument?

A: No, the sensor does not fit physically on the top plate.

Neither will the RCM 7/8 be able to read the standard SR10 signal.

Response Time and Performance Checks

RTPC 1

Q: Why is the response time of the sensor slow?

A: It is slow because of two reasons.

First, the foil is covered with an opaque optical isolation layer to make it more rugged.

The optical isolation slows down the time it takes for oxygen to equilibrate within the foil.

Second, the response time of the temperature sensor, needed to compensate the optical readings, is also a limiting factor. In most long term applications the response time ($t_{63} < 25$ s) is sufficient but when doing fast profiling (e.g. with a CTD or on a towed vehicle) the response time can be a limiting factor.

RTPC 2

Q: What is the maximum sampling rate of the sensor?

A: 1 sample/second (1Hz).

If sampling at rates faster than 1 sample/5seconds please be aware of potential self heating errors (maximal error due to self heating 1-2 μ M).

When sampling at high rates it is better to power the sensor with 5 V (instead of higher tensions) to reduce the self heating (see above).

RTPC 3

Q: Can I check that the sensor is giving correct readings without doing any Winkler titration's?

A: Yes, if you have a glass of water that is open to the air and bubbled with an air pump (normally used in aquariums, compressor type pumps should be avoided) the water will rapidly become 100% saturated and it stays saturated if you continue the bubbling.

The bubbling also ensures mixing in the glass so that oxygen gradients do not form in the water.

The absolute concentration (in μ M or mg/l) in this water, at saturation, is dependent on three parameters: the salinity, the temperature and the air pressure.

For example if the salinity is 0 ppt and the temperature is 20°C the oxygen concentration should be around 284 μ M but this value is given for an air-pressure of 1013 mbar.

The saturation values can be obtained from tables and/or mathematical formulas given in the Operating Manual.

If the air pressure is higher, for example 1030, you should expect higher readings of about $(1030-1013) / 1013 = 27 / 1013 = 2.7\%$ and if it is lower the readings should be lower.

If you would like to go further with your tests you can vary the temperature in the glass either by adding ice or by heating the water.

The saturation should then stay close to 100% at all the times but the absolute concentration will increase when the temperature goes down and decrease when it increases.

Of course the sensor should drop to 0 when you bubble the water with a different gas than air or oxygen (e.g. N₂ or Argon) or when you add for example Sodium sulfite to your water solution.

Please note that it can take quite some time before the water reaches a zero oxygen level when bubbling with gas.

Software, Settings, Communication and connection to various dataloggers (including CTD's)

SSC 1

Q: How do I most easily communicate and use the sensor from my PC? How do I calibrate it and set it up?

A: We recommend to use the OxyView software, which is available for a nominal license fee. This software is more or less self-explanatory and provides utilities, graphic & tabular display for set-up, calibration, logging etc. These functions are easily accessed without deeper knowledge about the sensor. As an alternative you can also communicate with any standard Terminal program (such as HyperTerminal included in Windows or Terra Terminal) but then you will have to read the Operating Manual carefully and every command has to be typed in separately.

SSC 2

Q: Many new PC's do not have a serial port. How can I communicate with the sensor without this?

A: The only way to communicate with the sensor is through the serial port. There are adaptors available that convert from USB to serial port. Experience has shown that these do not always function out of the box and may not be fully compatible with Windows or with your computer's specific software. It is recommended that you download the latest drivers from the Internet site of the manufacturer of the USB/serial adaptor. It has turned out that the drivers delivered with the adaptor are not always up to date.

SSC 3

Q: Which COM port is normally used when I use an USB/serial adaptor.

A: This varies from PC to PC and it has to be found out in the operative system.

SSC 4

Q: Is OxyView required to change the sampling interval? If not, how is it done?

A: No. However, it makes this process simpler. Communication and setting of sample intervals can all be done from a standard terminal program (like HyperTerminal). All this is explained in detail in the Operating Manual.

SSC 5

Q: What is the minimum supply voltage for the sensor?

A: The minimum supply is 5V the maximum is 14V.

SSC 6

Q: What is the peak current consumption for the sensor?

A: Less than 100mA (for 0.5 second).

SSC 7

Q: Is it possible to drive the Rx, Tx signals from the Optode directly by the 0-5V without a transceiver?

A: No, you must use RS-232 levels.

SSC 8

Q: When logging the sensor in RS232 format what is the minimum of signal lines we have to connect?

A: The minimum is four; TX, RX, Positive Supply and GND. For more information refer the Operating Manual.

SSC 9

Q: If you switch ON / switch OFF the power supply between the data acquisition, do you have to keep a delay time before acquiring some data or after a new switch ON?

A: Yes, the sensor will always do a sample after power up. The data output is after approximately 2 seconds. Approximately 2 seconds power off is needed to assure a new reset of the Optode. So in total it is recommended to supply power to the sensor for a minimum of 5 seconds during each sampling period.

SSC 10

Q: If I have internally set the sensors sample interval to 2 seconds and then decide to mount it on e.g. an RCM9 current meter, logging at a 1 hour sample interval, will there be a conflict between the sensor's internal interval and the one used by the RCM9?

A: No, there will not be any conflict. When the Optode is used with an Aanderaa data logger the power is only applied when the data-logger scans the connected sensors (Control Voltage is active). Every time the sensor is powered up, regardless of the internal interval settings, it will output one data reading (requires that the SR10 output is enabled, see Operating Manual for more information). The same happens for the RS-232 output. Even if the sensor is set up for long measurement intervals it will output new data every time power is connected. If power is connected continuously the sensor will measure at the programmed time interval (anything from 1 second and upwards).

SSC 11

Q: I have connected the Optode to my Aanderaa current meter but no data is delivered from the sensor, why?

A: The Optode output has to be set to -1 or -2 to present data on the SR10 output channel. Please refer to the Operating Manual or the OxyView software for more information on how this is done.

SSC 12

Q: What should I think about if I want to use the optode mounted on a CTD or a towed vehicle?

A: In spite of the relatively slow response time with respect to these applications many customers have chosen to use the sensor mounted on a CTD, a profiling vehicle or a towed vehicle. Users have selected the optode mainly because of the long-term stability and the absence of pressure hysteresis. Mainly pressure hysteresis makes electrochemical sensors unreliable when profiling at depths beyond 500-1000 meters. Whether the slow response time of the optode will be an impediment to getting good data or not depends of course on how strong the gradients are and at what speed you are profiling/towing. Data from some successful profiling applications are presented on the Aanderaa Internet pages.

SSC 13

Q: How should I connect and mount the sensor on for example a CTD or a towed vehicle?

A: If the CTD is equipped with a fast responding temperature sensor it is better to do the temperature compensation externally. This will improve the accuracy when subjected to fast temperature changes (when going through a gradient). The Optode must then be configured to output differential phase shift information (DPhase). Based on this data and the temperature data from the CTD, the oxygen concentration can be calculated with formulas (see the Operating Manual for details). If the CTD is not able to receive the RS-232 output, the Oxygen Optode 3975 with analog output can be used. The two channel "intelligent" digital to analog converter supplied with this sensor is able to output two channels of your selection (including DPhase). The optode has normally been mounted on the lower part of the CTD and with the window (where the foil is) close to a horizontal frame tube of the CTD. The hydrodynamic effect of the tube will then force water towards the foil and assures a good circulation both when going up and down. The optode of course has to be connected to the CTD with a cable.

SSC 14

Q: When powered on does the Optode expect a “XON” command before it starts or does it just start sending data?

A: The Optode does not wait for an “XON” before it starts.

Appendix 11 Oxygen Dynamics in Water

Seawater and Gases

Refer Unisense AS for tabulated physical parameters of interest to those working with micro sensors in marine systems:

<http://www.unisense.com/support/support.html>

Tables

Refer Unisense AS for Gas tables with diffusion coefficients, solubility of oxygen in seawater, density of water versus temperature and salinity, and much more:

http://www.unisense.com/support/pdf/gas_tables.pdf

Copies of Unisense AS tables for *solubility of oxygen in seawater* are given in Figure A , Figure A , and Figure A

NOTE! Refer Unisens AS for more information about the tables.



Oxygen solubility at different temperatures and salinities of seawater

Units: µmol/l

Salinity (%)	Temperature (°C)																				
	0.0	1.0	2.0	3.0	4.0	5.0	6.0	7.0	8.0	9.0	10.0	11.0	12.0	13.0	14.0	15.0	16.0	17.0	18.0	19.0	20.0
0.0	456.6	444.0	431.9	420.4	409.4	398.9	388.8	379.2	369.9	361.1	352.6	344.4	336.6	329.1	321.9	314.9	308.3	301.8	295.6	289.7	283.9
1.0	453.5	441.0	429.0	417.6	406.7	396.3	386.3	376.7	367.6	358.8	350.4	342.3	334.5	327.1	319.9	313.0	306.4	300.0	293.9	287.9	282.2
2.0	450.4	438.0	426.1	414.8	404.0	393.6	383.7	374.3	365.2	356.5	348.1	340.1	332.4	325.0	317.9	311.1	304.5	298.2	292.1	286.2	280.6
3.0	447.3	435.0	423.2	412.0	401.3	391.0	381.2	371.8	362.8	354.2	345.9	338.0	330.4	323.0	316.0	309.2	302.7	296.4	290.4	284.5	278.9
4.0	444.2	432.0	420.4	409.2	398.6	388.5	378.7	369.4	360.5	351.9	343.7	335.9	328.3	321.0	314.0	307.3	300.9	294.6	288.6	282.9	277.3
5.0	441.1	429.1	417.5	406.5	396.0	385.9	376.3	367.0	358.2	349.7	341.6	333.7	326.2	319.0	312.1	305.5	299.0	292.9	286.9	281.2	275.7
6.0	438.1	426.1	414.7	403.8	393.3	383.3	373.8	364.6	355.9	347.5	339.4	331.6	324.2	317.1	310.2	303.6	297.2	291.1	285.2	279.5	274.0
7.0	435.1	423.2	411.9	401.1	390.7	380.8	371.3	362.3	353.6	345.2	337.2	329.6	322.2	315.1	308.3	301.7	295.4	289.4	283.5	277.9	272.4
8.0	432.1	420.3	409.1	398.4	388.1	378.3	368.9	359.9	351.3	343.0	335.1	327.5	320.2	313.1	306.4	299.9	293.6	287.6	281.8	276.2	270.8
9.0	429.1	417.5	406.3	395.7	385.5	375.8	366.5	357.6	349.0	340.8	333.0	325.4	318.2	311.2	304.5	298.1	291.9	285.9	280.1	274.6	269.2
10.0	426.1	414.6	403.6	393.0	383.0	373.3	364.1	355.2	346.8	338.6	330.8	323.4	316.2	309.3	302.6	296.2	290.1	284.2	278.5	273.0	267.6
11.0	423.2	411.8	400.8	390.4	380.4	370.8	361.7	352.9	344.5	336.5	328.7	321.3	314.2	307.3	300.8	294.4	288.3	282.5	276.8	271.3	266.1
12.0	420.3	409.0	398.1	387.8	377.9	368.4	359.3	350.6	342.3	334.3	326.7	319.3	312.2	305.4	298.9	292.6	286.6	280.8	275.1	269.7	264.5
13.0	417.4	406.2	395.4	385.2	375.3	366.0	357.0	348.3	340.1	332.2	324.6	317.3	310.3	303.5	297.1	290.8	284.8	279.1	273.5	268.1	262.9
14.0	414.5	403.4	392.7	382.6	372.8	363.5	354.6	346.1	337.9	330.0	322.5	315.3	308.3	301.7	295.2	289.1	283.1	277.4	271.9	266.5	261.4
15.0	411.7	400.6	390.1	380.0	370.4	361.1	352.3	343.8	335.7	327.9	320.5	313.3	306.4	299.8	293.4	287.3	281.4	275.7	270.2	265.0	259.9
16.0	408.8	397.9	387.4	377.4	367.9	358.7	350.0	341.6	333.5	325.8	318.4	311.3	304.5	297.9	291.6	285.5	279.7	274.0	268.6	263.4	258.3
17.0	406.0	395.2	384.8	374.9	365.4	356.4	347.7	339.4	331.4	323.7	316.4	309.4	302.6	296.1	289.8	283.8	278.0	272.4	267.0	261.8	256.8
18.0	403.2	392.5	382.2	372.4	363.0	354.0	345.4	337.2	329.2	321.7	314.4	307.4	300.7	294.2	288.0	282.1	276.3	270.8	265.4	260.3	255.3
19.0	400.4	389.8	379.6	369.9	360.6	351.7	343.1	335.0	327.1	319.6	312.4	305.5	298.8	292.4	286.3	280.3	274.6	269.1	263.8	258.7	253.8
20.0	397.7	387.1	377.0	367.4	358.2	349.3	340.9	332.8	325.0	317.6	310.4	303.5	296.9	290.6	284.5	278.6	273.0	267.5	262.3	257.2	252.3
21.0	394.9	384.5	374.5	364.9	355.8	347.0	338.6	330.6	322.9	315.5	308.4	301.6	295.1	288.8	282.7	276.9	271.3	265.9	260.7	255.7	250.8
22.0	392.2	381.8	371.9	362.4	353.4	344.7	336.4	328.5	320.8	313.5	306.5	299.7	293.2	287.0	281.0	275.2	269.7	264.3	259.1	254.1	249.3
23.0	389.5	379.2	369.4	360.0	351.0	342.4	334.2	326.3	318.7	311.5	304.5	297.8	291.4	285.2	279.3	273.5	268.0	262.7	257.6	252.6	247.9
24.0	386.8	376.6	366.9	357.6	348.7	340.2	332.0	324.2	316.7	309.5	302.6	295.9	289.6	283.4	277.5	271.9	266.4	261.1	256.0	251.1	246.4
25.0	384.1	374.0	364.4	355.2	346.4	337.9	329.8	322.1	314.6	307.5	300.7	294.1	287.8	281.7	275.8	270.2	264.8	259.5	254.5	249.6	244.9
26.0	381.5	371.5	361.9	352.8	344.0	335.7	327.7	320.0	312.6	305.5	298.7	292.2	285.9	279.9	274.1	268.5	263.2	258.0	253.0	248.2	243.5
27.0	378.8	368.9	359.5	350.4	341.7	333.4	325.5	317.9	310.6	303.6	296.8	290.4	284.2	278.2	272.4	266.9	261.6	256.4	251.5	246.7	242.1
28.0	376.2	366.4	357.0	348.0	339.5	331.2	323.4	315.8	308.6	301.6	294.9	288.5	282.4	276.5	270.7	265.3	260.0	254.9	250.0	245.2	240.6
29.0	373.6	363.9	354.6	345.7	337.2	329.0	321.2	313.8	306.6	299.7	293.1	286.7	280.6	274.7	269.1	263.6	258.4	253.3	248.5	243.8	239.2
30.0	371.0	361.4	352.2	343.4	334.9	326.9	319.1	311.7	304.6	297.8	291.2	284.9	278.8	273.0	267.4	262.0	256.8	251.8	247.0	242.3	237.8
31.0	368.5	358.9	349.8	341.1	332.7	324.7	317.0	309.7	302.6	295.9	289.3	283.1	277.1	271.3	265.8	260.4	255.3	250.3	245.5	240.9	236.4
32.0	365.9	356.5	347.4	338.8	330.5	322.5	314.9	307.7	300.7	294.0	287.5	281.3	275.4	269.6	264.1	258.8	253.7	248.8	244.0	239.4	235.0
33.0	363.4	354.0	345.1	336.5	328.3	320.4	312.9	305.6	298.7	292.1	285.7	279.5	273.6	268.0	262.5	257.2	252.2	247.3	242.6	238.0	233.6
34.0	360.9	351.6	342.7	334.2	326.1	318.3	310.8	303.7	296.8	290.2	283.9	277.8	271.9	266.3	260.9	255.7	250.6	245.8	241.1	236.6	232.2
35.0	358.4	349.2	340.3	332.0	323.9	316.2	308.8	301.7	294.9	288.3	282.0	276.0	270.2	264.6	259.3	254.1	249.1	244.3	239.7	235.2	230.9
36.0	355.9	346.8	338.1	329.7	321.7	314.1	306.7	299.7	293.0	286.5	280.3	274.3	268.5	263.0	257.7	252.5	247.6	242.8	238.2	233.8	229.5
37.0	353.5	344.4	335.8	327.5	319.6	312.0	304.7	297.7	291.1	284.6	278.5	272.5	266.8	261.4	256.1	251.0	246.1	241.4	236.8	232.4	228.2
38.0	351.0	342.0	333.5	325.3	317.4	309.9	302.7	295.8	289.2	282.8	276.7	270.8	265.2	259.7	254.5	249.5	244.6	239.9	235.4	231.0	226.8
39.0	348.6	339.7	331.2	323.1	315.3	307.9	300.7	293.9	287.3	281.0	274.9	269.1	263.5	258.1	252.9	247.9	243.1	238.5	234.0	229.7	225.5
40.0	346.2	337.4	329.0	320.9	313.2	305.8	298.7	292.0	285.4	279.2	273.2	267.4	261.8	256.5	251.4	246.4	241.6	237.0	232.6	228.3	224.1

Figure A 20 Copy of Data Table 6 by Niels Ramsing and Jens Gundersen: 100% Oxygen Solubility @ 1013 mbar pressure



Oxygen solubility at different temperatures and salinities of seawater

Units: $\mu\text{mol/l}$

Salinity (%)	Temperature (°C)																				
	20.0	21.0	22.0	23.0	24.0	25.0	26.0	27.0	28.0	29.0	30.0	31.0	32.0	33.0	34.0	35.0	36.0	37.0	38.0	39.0	40.0
0.0	283.9	278.3	273.0	267.8	262.8	257.9	253.2	248.7	244.3	240.0	235.9	231.9	228.0	224.2	220.5	217.0	213.5	210.1	206.7	203.5	200.4
1.0	282.2	276.7	271.4	266.3	261.3	256.5	251.8	247.3	243.0	238.7	234.6	230.6	226.8	223.0	219.4	215.8	212.3	209.0	205.7	202.5	199.3
2.0	280.6	275.1	269.8	264.7	259.8	255.0	250.4	245.9	241.6	237.4	233.3	229.4	225.6	221.8	218.2	214.7	211.2	207.9	204.6	201.4	198.3
3.0	278.9	273.5	268.3	263.2	258.3	253.6	249.0	244.6	240.3	236.1	232.1	228.1	224.3	220.6	217.0	213.5	210.1	206.8	203.6	200.4	197.3
4.0	277.3	271.9	266.7	261.7	256.8	252.1	247.6	243.2	238.9	234.8	230.8	226.9	223.1	219.5	215.9	212.4	209.0	205.7	202.5	199.4	196.3
5.0	275.7	270.3	265.2	260.2	255.4	250.7	246.2	241.8	237.6	233.5	229.5	225.7	221.9	218.3	214.7	211.3	207.9	204.6	201.4	198.3	195.3
6.0	274.0	268.7	263.6	258.7	253.9	249.3	244.8	240.5	236.3	232.2	228.3	224.4	220.7	217.1	213.6	210.2	206.8	203.6	200.4	197.3	194.3
7.0	272.4	267.2	262.1	257.2	252.5	247.9	243.4	239.1	235.0	230.9	227.0	223.2	219.5	215.9	212.4	209.0	205.7	202.5	199.4	196.3	193.3
8.0	270.8	265.6	260.6	255.7	251.0	246.5	242.1	237.8	233.7	229.7	225.8	222.0	218.3	214.8	211.3	207.9	204.7	201.5	198.3	195.3	192.3
9.0	269.2	264.1	259.1	254.2	249.6	245.1	240.7	236.5	232.4	228.4	224.5	220.8	217.2	213.6	210.2	206.8	203.6	200.4	197.3	194.3	191.3
10.0	267.6	262.5	257.6	252.8	248.2	243.7	239.4	235.2	231.1	227.1	223.3	219.6	216.0	212.5	209.1	205.7	202.5	199.4	196.3	193.3	190.3
11.0	266.1	261.0	256.1	251.3	246.7	242.3	238.0	233.8	229.8	225.9	222.1	218.4	214.8	211.3	208.0	204.7	201.4	198.3	195.3	192.3	189.4
12.0	264.5	259.5	254.6	249.9	245.3	240.9	236.7	232.5	228.5	224.6	220.9	217.2	213.7	210.2	206.8	203.6	200.4	197.3	194.2	191.3	188.4
13.0	262.9	257.9	253.1	248.4	243.9	239.6	235.3	231.2	227.3	223.4	219.7	216.0	212.5	209.1	205.7	202.5	199.3	196.2	193.2	190.3	187.4
14.0	261.4	256.4	251.6	247.0	242.5	238.2	234.0	229.9	226.0	222.2	218.5	214.9	211.4	208.0	204.6	201.4	198.3	195.2	192.2	189.3	186.5
15.0	259.9	254.9	250.2	245.6	241.1	236.8	232.7	228.6	224.7	220.9	217.3	213.7	210.2	206.8	203.6	200.4	197.2	194.2	191.2	188.3	185.5
16.0	258.3	253.4	248.7	244.2	239.8	235.5	231.4	227.4	223.5	219.7	216.1	212.5	209.1	205.7	202.5	199.3	196.2	193.2	190.2	187.4	184.6
17.0	256.8	252.0	247.3	242.8	238.4	234.2	230.1	226.1	222.2	218.5	214.9	211.4	208.0	204.6	201.4	198.2	195.2	192.2	189.3	186.4	183.6
18.0	255.3	250.5	245.9	241.4	237.0	232.8	228.8	224.8	221.0	217.3	213.7	210.2	206.8	203.5	200.3	197.2	194.1	191.2	188.3	185.4	182.7
19.0	253.8	249.0	244.4	240.0	235.7	231.5	227.5	223.6	219.8	216.1	212.5	209.1	205.7	202.4	199.2	196.1	193.1	190.2	187.3	184.5	181.7
20.0	252.3	247.6	243.0	238.6	234.3	230.2	226.2	222.3	218.6	214.9	211.4	207.9	204.6	201.3	198.2	195.1	192.1	189.2	186.3	183.5	180.8
21.0	250.8	246.1	241.6	237.2	233.0	228.9	224.9	221.1	217.3	213.7	210.2	206.8	203.5	200.3	197.1	194.1	191.1	188.2	185.4	182.6	179.9
22.0	249.3	244.7	240.2	235.8	231.7	227.6	223.6	219.8	216.1	212.5	209.1	205.7	202.4	199.2	196.1	193.0	190.1	187.2	184.4	181.6	179.0
23.0	247.9	243.2	238.8	234.5	230.3	226.3	222.4	218.6	214.9	211.4	207.9	204.6	201.3	198.1	195.0	192.0	189.1	186.2	183.4	180.7	178.0
24.0	246.4	241.8	237.4	233.1	229.0	225.0	221.1	217.4	213.7	210.2	206.8	203.4	200.2	197.1	194.0	191.0	188.1	185.2	182.5	179.8	177.1
25.0	244.9	240.4	236.0	231.8	227.7	223.7	219.9	216.2	212.5	209.0	205.6	202.3	199.1	196.0	193.0	190.0	187.1	184.3	181.5	178.8	176.2
26.0	243.5	239.0	234.7	230.5	226.4	222.5	218.6	214.9	211.4	207.9	204.5	201.2	198.0	194.9	191.9	189.0	186.1	183.3	180.6	177.9	175.3
27.0	242.1	237.6	233.3	229.1	225.1	221.2	217.4	213.7	210.2	206.7	203.4	200.1	197.0	193.9	190.9	188.0	185.1	182.4	179.6	177.0	174.4
28.0	240.6	236.2	231.9	227.8	223.8	219.9	216.2	212.5	209.0	205.6	202.3	199.0	195.9	192.9	189.9	187.0	184.2	181.4	178.7	176.1	173.5
29.0	239.2	234.8	230.6	226.5	222.5	218.7	215.0	211.4	207.9	204.5	201.2	198.0	194.8	191.8	188.9	186.0	183.2	180.5	177.8	175.2	172.6
30.0	237.8	233.5	229.3	225.2	221.3	217.4	213.7	210.2	206.7	203.3	200.1	196.9	193.8	190.8	187.9	185.0	182.2	179.5	176.9	174.3	171.7
31.0	236.4	232.1	227.9	223.9	220.0	216.2	212.5	209.0	205.5	202.2	199.0	195.8	192.7	189.8	186.9	184.0	181.3	178.6	175.9	173.4	170.9
32.0	235.0	230.7	226.6	222.6	218.7	215.0	211.3	207.8	204.4	201.1	197.9	194.7	191.7	188.7	185.9	183.0	180.3	177.6	175.0	172.5	170.0
33.0	233.6	229.4	225.3	221.3	217.5	213.8	210.1	206.7	203.3	200.0	196.8	193.7	190.7	187.7	184.9	182.1	179.4	176.7	174.1	171.6	169.1
34.0	232.2	228.0	224.0	220.0	216.2	212.5	209.0	205.5	202.1	198.9	195.7	192.6	189.6	186.7	183.9	181.1	178.4	175.8	173.2	170.7	168.2
35.0	230.9	226.7	222.7	218.8	215.0	211.3	207.8	204.3	201.0	197.8	194.6	191.6	188.6	185.7	182.9	180.1	177.5	174.9	172.3	169.8	167.4
36.0	229.5	225.4	221.4	217.5	213.8	210.1	206.6	203.2	199.9	196.7	193.6	190.5	187.6	184.7	181.9	179.2	176.5	173.9	171.4	168.9	166.5
37.0	228.2	224.1	220.1	216.2	212.5	208.9	205.4	202.1	198.8	195.6	192.5	189.5	186.6	183.7	180.9	178.2	175.6	173.0	170.5	168.1	165.7
38.0	226.8	222.7	218.8	215.0	211.3	207.7	204.3	200.9	197.7	194.5	191.4	188.5	185.6	182.7	180.0	177.3	174.7	172.1	169.6	167.2	164.8
39.0	225.5	221.4	217.5	213.8	210.1	206.6	203.1	199.8	196.6	193.4	190.4	187.4	184.5	181.7	179.0	176.3	173.8	171.2	168.7	166.3	164.0
40.0	224.1	220.1	216.3	212.5	208.9	205.4	202.0	198.7	195.5	192.4	189.3	186.4	183.5	180.8	178.1	175.4	172.8	170.3	167.9	165.5	163.1

Figure A 21 Copy of Data Table 7 by Niels Ramsing and Jens Gundersen: 100% Oxygen Solubility @1013 mbar pressure



Oxygen solubility at different temperatures and salinities of seawater

Units: µmol/l

Salinity (%)	Temperature (°C)																				
	0.0	5.0	10.0	15.0	20.0	25.0	30.0	35.0	40.0	45.0	50.0	55.0	60.0	65.0	70.0	75.0	80.0	85.0	90.0	95.0	100.0
0.0	456.6	398.9	352.6	314.9	283.9	257.9	235.9	217.0	200.4	185.6	172.2	159.9	148.3	137.2	126.5	115.9	105.5	95.1	84.7	74.5	64.3
5.0	441.1	385.9	341.6	305.5	275.7	250.7	229.5	211.3	195.3	181.0	168.1	156.2	145.0	134.2	123.8	113.6	103.4	93.3	83.2	73.2	63.3
10.0	426.1	373.3	330.8	296.2	267.6	243.7	223.3	205.7	190.3	176.6	164.1	152.6	141.7	131.3	121.2	111.3	101.4	91.6	81.7	71.9	62.2
15.0	411.7	361.1	320.5	287.3	259.9	236.8	217.3	200.4	185.5	172.3	160.2	149.1	138.6	128.5	118.7	109.0	99.4	89.8	80.2	70.7	61.2
20.0	397.7	349.3	310.4	278.6	252.3	230.2	211.4	195.1	180.8	168.0	156.4	145.6	135.5	125.7	116.2	106.8	97.5	88.1	78.8	69.4	60.2
25.0	384.1	337.9	300.7	270.2	244.9	223.7	205.6	190.0	176.2	163.9	152.7	142.3	132.4	123.0	113.7	104.6	95.5	86.4	77.3	68.2	59.2
30.0	371.0	326.9	291.2	262.0	237.8	217.4	200.1	185.0	171.7	159.9	149.0	139.0	129.4	120.3	111.3	102.5	93.6	84.8	75.9	67.0	58.2
35.0	358.4	316.2	282.0	254.1	230.9	211.3	194.6	180.1	167.4	155.9	145.5	135.7	126.5	117.7	109.0	100.4	91.8	83.2	74.5	65.8	57.2
40.0	346.2	305.8	273.2	246.4	224.1	205.4	189.3	175.4	163.1	152.1	142.0	132.6	123.7	115.1	106.7	98.3	90.0	81.6	73.1	64.7	56.3
45.0	334.4	295.8	264.6	238.9	217.6	199.6	184.2	170.8	159.0	148.3	138.6	129.5	120.9	112.6	104.4	96.3	88.2	80.0	71.8	63.5	55.3
50.0	323.0	286.1	256.3	231.7	211.3	194.0	179.2	166.3	154.9	144.7	135.3	126.5	118.2	110.1	102.2	94.3	86.4	78.5	70.5	62.4	54.4
55.0	311.9	276.7	248.2	224.7	205.1	188.5	174.3	161.9	151.0	141.1	132.1	123.6	115.5	107.7	100.0	92.4	84.7	77.0	69.2	61.3	53.5
60.0	301.3	267.7	240.4	217.9	199.1	183.2	169.6	157.7	147.1	137.6	128.9	120.7	112.9	105.4	97.9	90.5	83.0	75.5	67.9	60.2	52.6
65.0	291.0	258.9	232.8	211.3	193.3	178.1	165.0	153.5	143.4	134.2	125.8	117.9	110.4	103.1	95.8	88.6	81.4	74.1	66.6	59.2	51.7
70.0	281.0	250.4	225.5	204.9	187.7	173.0	160.5	149.5	139.8	130.9	122.8	115.2	107.9	100.8	93.8	86.8	79.8	72.6	65.4	58.1	50.8
75.0	271.4	242.2	218.4	198.7	182.2	168.2	156.1	145.6	136.2	127.7	119.9	112.5	105.5	98.6	91.8	85.0	78.2	71.2	64.2	57.1	50.0
80.0	262.2	234.2	211.5	192.6	176.8	163.4	151.9	141.7	132.7	124.6	117.0	109.9	103.1	96.4	89.9	83.3	76.6	69.9	63.0	56.1	49.1
85.0	253.2	226.6	204.8	186.8	171.7	158.8	147.7	138.0	129.3	121.5	114.2	107.3	100.8	94.3	88.0	81.6	75.1	68.5	61.8	55.1	48.3
90.0	244.5	219.1	198.3	181.1	166.7	154.3	143.7	134.4	126.0	118.5	111.5	104.9	98.5	92.3	86.1	79.9	73.6	67.2	60.7	54.1	47.5
95.0	236.2	211.9	192.1	175.6	161.8	150.0	139.8	130.8	122.8	115.6	108.8	102.4	96.3	90.2	84.3	78.2	72.1	65.9	59.6	53.1	46.6
100.0	228.1	205.0	186.0	170.3	157.1	145.8	136.0	127.4	119.7	112.7	106.2	100.0	94.1	88.3	82.5	76.6	70.7	64.6	58.4	52.2	45.8
105.0	220.3	198.2	180.2	165.1	152.5	141.7	132.3	124.0	116.7	109.9	103.6	97.7	92.0	86.3	80.7	75.0	69.3	63.4	57.4	51.2	45.1
110.0	212.7	191.7	174.5	160.1	148.0	137.7	128.7	120.8	113.7	107.2	101.2	95.4	89.9	84.4	79.0	73.5	67.9	62.1	56.3	50.3	44.3
115.0	205.4	185.4	169.0	155.2	143.7	133.8	125.2	117.6	110.8	104.5	98.7	93.2	87.9	82.6	77.3	72.0	66.5	60.9	55.2	49.4	43.5
120.0	198.4	179.3	163.6	150.5	139.5	130.0	121.8	114.5	108.0	102.0	96.4	91.0	85.9	80.8	75.7	70.5	65.2	59.8	54.2	48.5	42.8
125.0	191.6	173.4	158.5	146.0	135.4	126.3	118.4	111.5	105.2	99.4	94.1	88.9	83.9	79.0	74.0	69.0	63.9	58.6	53.2	47.7	42.1
130.0	185.0	167.7	153.4	141.5	131.4	122.8	115.2	108.5	102.5	97.0	91.8	86.9	82.0	77.3	72.5	67.6	62.6	57.5	52.2	46.8	41.3
135.0	178.7	162.2	148.6	137.2	127.6	119.3	112.1	105.7	99.9	94.6	89.6	84.8	80.2	75.6	70.9	66.2	61.3	56.4	51.2	46.0	40.6
140.0	172.6	156.9	143.9	133.1	123.8	115.9	109.0	102.9	97.3	92.2	87.4	82.9	78.4	73.9	69.4	64.8	60.1	55.3	50.3	45.1	39.9
145.0	166.6	151.7	139.4	129.0	120.2	112.7	106.0	100.2	94.9	90.0	85.4	80.9	76.6	72.3	67.9	63.5	58.9	54.2	49.3	44.3	39.2
150.0	160.9	146.7	134.9	125.1	116.7	109.5	103.2	97.5	92.4	87.7	83.3	79.0	74.9	70.7	66.5	62.2	57.7	53.1	48.4	43.5	38.6
155.0	155.4	141.9	130.7	121.3	113.3	106.4	100.3	95.0	90.1	85.6	81.3	77.2	73.2	69.1	65.1	60.9	56.6	52.1	47.5	42.7	37.9
160.0	150.1	137.2	126.5	117.6	110.0	103.4	97.6	92.5	87.8	83.4	79.3	75.4	71.5	67.6	63.7	59.6	55.4	51.1	46.6	42.0	37.2
165.0	144.9	132.7	122.5	114.0	106.7	100.5	94.9	90.0	85.5	81.4	77.4	73.6	69.9	66.1	62.3	58.4	54.3	50.1	45.7	41.2	36.6
170.0	139.9	128.3	118.7	110.5	103.6	97.6	92.3	87.6	83.4	79.4	75.6	71.9	68.3	64.7	61.0	57.2	53.2	49.1	44.9	40.5	36.0
175.0	135.1	124.1	114.9	107.2	100.6	94.9	89.8	85.3	81.2	77.4	73.8	70.2	66.8	63.3	59.7	56.0	52.1	48.2	44.0	39.7	35.3
180.0	130.5	120.0	111.3	103.9	97.6	92.2	87.4	83.1	79.1	75.5	72.0	68.6	65.2	61.9	58.4	54.8	51.1	47.2	43.2	39.0	34.7
185.0	126.0	116.0	107.8	100.8	94.8	89.6	85.0	80.9	77.1	73.6	70.3	67.0	63.8	60.5	57.1	53.7	50.1	46.3	42.4	38.3	34.1
190.0	121.7	112.2	104.3	97.7	92.0	87.0	82.7	78.7	75.2	71.8	68.6	65.4	62.3	59.2	55.9	52.6	49.1	45.4	41.6	37.6	33.5
195.0	117.5	108.5	101.0	94.7	89.3	84.6	80.4	76.7	73.2	70.0	66.9	63.9	60.9	57.9	54.7	51.5	48.1	44.5	40.8	36.9	32.9
200.0	113.5	104.9	97.8	91.8	86.7	82.2	78.2	74.6	71.4	68.3	65.3	62.4	59.5	56.6	53.6	50.4	47.1	43.6	40.0	36.3	32.4

Figure A 22 Copy of Data Table 8 by Niels Ramsing and Jens Gundersen: 100% Oxygen Solubility @1013 mbar pressure