

Energy Management of Hybrid Electric Vehicles: 15 Years of Development at the Ohio State University

Giorgio Rizzoni¹ and Simona Onori^{2*}

¹ Center for Automotive Research and Department of Mechanical and Aerospace Engineering,
The Ohio State University Columbus, OH 43212 - USA

² Automotive Engineering Department, Clemson University, Greenville, SC 29607 - USA
e-mail: rizzoni.1@osu.edu - sonori@clemson.edu

* Corresponding author

Abstract — *The aim of this paper is to document 15 years of hybrid electric vehicle energy management research at The Ohio State University Center for Automotive Research (OSU-CAR). Hybrid Electric Vehicle (HEV) technology encompasses many diverse aspects. In this paper, we focus exclusively on the evolution of supervisory control strategies for on-board energy management in HEV. We present a series of control algorithms that have been developed in simulation and implemented in prototype vehicles for charge-sustaining HEV at OSU-CAR. These solutions span from fuzzy-logic control algorithms to more sophisticated model-based optimal control methods. Finally, methods developed for plug-in HEV energy management are also discussed.*

Résumé — **Gestion énergétique des véhicules hybrides électriques : 15 ans de développement à l'université d'État de l'Ohio** — Le but de cet article est de documenter 15 ans de recherche sur la gestion énergétique des véhicules hybrides électriques, effectuée au centre de recherche automobile de l'Ohio State University (OSU-CAR). La technologie VHE (Véhicules Hybrides Électriques) englobe divers aspects. Dans cet article, nous nous concentrons exclusivement sur l'évolution des stratégies de contrôle de surveillance pour la gestion énergétique embarquée dans les VHE. Nous présentons une série d'algorithmes de contrôle qui, à l'OSU-CAR, ont été développés en simulation et mis en œuvre dans des véhicules prototypes pour les VHE avec maintien de la charge. Ces solutions couvrent tant les algorithmes de contrôle par logique floue que les méthodes sophistiquées de contrôle optimal basé sur un modèle. Enfin, les méthodes développées pour la gestion énergétique des VHR (Véhicules Hybrides Rechargeables) sont également abordées.

INTRODUCTION

The aim of this paper is to document 15 years of Hybrid Electric Vehicle (HEV) energy management research at the Ohio State University Center for Automotive Research (OSU-CAR). The activities described in this review paper began in the second half of the 1990s, and have taken place in parallel with the commercial introduction of hybrid vehicles, dating back with the first offering of the *Toyota Prius* in Japan in 1998, and of the *Honda Insight* in the USA in 1999. In this paper, we focus exclusively on the evolution of energy management strategies for HEV, and not on the underlying hardware or architectures. It should be noted that the evolution of technology has brought forth new possibilities (for example, Plug-in Hybrid Electric Vehicles (PHEV)), and that these changes have provided new ideas and motivation. Many other researchers, in industrial and academic research organizations, have addressed similar and diverse aspects of HEV research. While today many institutions worldwide conduct research on HEV, at the beginning six main research groups have been extremely active in the development of energy strategies for HEV. The most significant contributions in this area are from researchers at: OSU-CAR (this paper deals with 15 years worth of research results produced by researchers at this institution); ETH Zurich (Sciarretta *et al.*, 2003, 2004; Rodatz *et al.*, 2005; Sundström *et al.*, 2008, 2010; Sundström and Guzzella, 2009; Ambuhl and Guzzella, 2009), University of l'Aquila, (Anatone *et al.*, 2005; Cipollone and Sciarretta, 2006); IFP Energies nouvelles (IFPEN) in France (Chasse *et al.*, 2009); IFPEN and ETH (Guzzella and Sciarretta, 2007); University of Michigan Ann Arbor (Lin *et al.*, 2001, 2003, 2006; Wu *et al.*, 2004; Tate *et al.*, 2007; Liu and Peng, 2008); Eindhoven University of Technology (Kessels *et al.*, 2006, 2008; Kessels, 2007).

This paper is not intended to be a comprehensive review of all of the developments in this field. We hope that the bibliographical references provide a reasonably broad overview of what (many) others have done.

Historical Notes

In 1993, eight agencies of the US government formed a partnership with the three major North-American automotive OEM to advance vehicle technology, with the goal of producing highly fuel-efficient vehicles. The Partnership for a New Generation of Vehicles, PNGV, involved *DaimlerChrysler*, *Ford*, and *General Motors*, through the United States Council for Automotive Research (USCAR); its most widely publicized (but not only) goal was to put in production vehicles capable

of achieving 80 miles per gallon (approximately 3 liters per 100 km) by 2003. The program ended in 2001, due to the transition between the Clinton-Gore and the Bush administrations, with the automakers having demonstrated (but not launched production of) the *GM Precept*, the *Ford Prodigy* and the *Chrysler ESX*. All of these vehicles were characterized by the use of lightweight materials, hybrid powertrains, and other technological innovations. PNGV provided the opportunity for a number of US universities to collaborate with USCAR and with federal agencies towards the development of fuel-efficient vehicles.

HEV Research and Development at Ohio State

The Ohio State University was engaged in programs focused on the development of vehicle prototypes and on the development of energy management strategies and algorithms, as early as 1996. In particular, during the PNGV years the US Department of Energy collaborated with USCAR in creating a series of competitions that were part of the Advanced Vehicle Technology Competitions (AVTC) program and which focused on the development of high-fuel-economy vehicle prototypes that were in practice almost invariably hybrids. Through these competitions, which have continued without interruption since 1996, OSU faculty and students have developed 7 hybrid vehicle prototypes based on mid-size sedans (FutureCar 1996-97 and 1998-99, and EcoCAR 2 2012-14), full-size SUV (FutureTruck 2000-01 and 2002-04), and crossover SUV (ChallengeX 2005-08 and EcoCAR 2009-11). Further, the OSU-CAR has been continuously engaged in research programs related to hybrid vehicle development with a number of industry and government research sponsors, and focusing on military, commercial and passenger vehicles. Supervisory energy management of the hybrid powertrain is a critical element in each of these projects.

1 BACKGROUND

1.1 Hybrid Vehicles

Hybrid electric vehicles encompass two (or more) energy storage sources and associated energy converters. Most typically, the architecture of these vehicles includes an internal combustion engine with an associated fuel tank and one or more electric machine(s), requiring a battery system to store electrical energy. HEV are generally classified according to their powertrain architectures. A series hybrid employs a large electric motor to propel

the vehicle while using the Internal Combustible Engine (ICE) and a second electric machine to generate electricity for the battery. A parallel hybrid can combine power from the ICE and the electric motor(s) to deliver mechanical power to the road or to recharge the battery as necessary. A third configuration is the power-split or multi-mode hybrid with the properties of both a series and parallel hybrids. Today, this last configuration is the most commonly employed in commercially produced hybrids. A further distinction among HEV is their electrical power system autonomy: an HEV is considered charge sustaining if the electric energy storage system is recharged only by power supplied by the ICE or by regenerative braking. If, on the other hand, the vehicle is designed to deplete stored energy in the battery during the course of a trip, ending the trip with a lower state of charge than at the start and requiring re-charging, the vehicle is called charge depleting, or plug-in hybrid (PHEV).

1.2 The Energy Management Problem

Control strategies for hybrid electric vehicles are aimed at meeting several simultaneous objectives. The primary one is usually the minimization of the vehicle fuel consumption, but minimizing engine emissions and maintaining or enhancing driveability are also important objectives. Regardless of the topology of these components, the essence of the HEV control problem is the instantaneous management of the power flows from two or more energy converters to achieve the overall control objectives. One important characteristic of this general problem is that the control objectives are mostly integral in nature (fuel consumption and emission per mile of travel), or semi-local in time, such as driveability, while the control actions are local in time. Furthermore, the control objectives are often subject to integral constraints, such as maintaining the battery State of Charge (SOC) within a prescribed range in charge-sustaining hybrids. The global nature of both the objectives and the constraints does not lend itself to traditional global optimization technique, as the future is unknown in actual driving circumstances. Much can be learned from global optimization exercises over a priori known driving cycles. However, these solutions do not directly lend themselves to practical implementations. In this paper, we review the evolution of practical and theoretical HEV optimal energy management strategies that optimize the power split between energy converters, while accounting for global constraints. The optimal energy management problem in a hybrid electric vehicle consists in finding the

sequence of controls $u(t)$ that leads to the minimization of a performance index J , defined as:

$$J(x(t), u(t)) = \int_{t_0}^{t_f} L(x(t), u(t), t) dt \quad (1)$$

where t represents the time, $u(t)$ is the control action, $x(t)$ is the state variable, $[t_0, t_f]$ is the optimization horizon, $L(\cdot)$ is the instantaneous cost function. If all fast dynamics in the powertrain are neglected, as well as the thermal phenomena, the vehicle can be described as a system in which the battery state of charge, $\text{SOC}=x$, is the only state variable and whose dynamics are given by:

$$\dot{x}(t) = f(x, u, t) = -\frac{1}{Q_{batt}} I_{batt}(x, u, t) \quad (2)$$

where I_{batt} is the battery current (positive in discharging and negative in charging) and Q_{batt} the battery charge capacity.

The control variable $u(t)$ is the vector of control variables. The number of control variables in the energy management problem depends on the number of degree of freedom in the powertrain architecture. If the powertrain only has one degree of freedom, then $u(t) = P_{batt}(t)$.

If fuel consumption minimization is the only optimization objective, the instantaneous cost is the fuel flow rate, or the power equivalent to it:

$$L(u, t) = P_{fuel}(u, t) = Q_{lhv} \dot{m}_f(u, t) \quad (3)$$

where Q_{lhv} is the lower heating value of the fuel and \dot{m}_f the fuel flow rate. The energy management problem can be cast into a constrained optimization problem where the objective is to minimize (1) with L given as in (3) subject to dynamic constraints (2) with the inclusion of the following additional constraints:

State and input instantaneous constraints:

$$u_{min}(t) \leq u(t) \leq u_{max}(t) \forall t \in [0, t_f] \quad (4)$$

$$x_{min} \leq x(t) \leq x_{max} \forall t \in [0, t_f] \quad (5)$$

Global constraints on the state of charge:

$$x(t_0) = x_{ref}, x(t_f) = x_{ref} \quad (6)$$

This latter constraint could be expressed in other ways, for example by forcing $x(t)$ to stay within prescribed bounds. The formulation above has some advantages in formally defining the problem, as it will become clear in a later section.

The optimal control law is denoted as $u^*(t)$ and the corresponding state trajectory as $x^*(t)$.

2 ENERGY MANAGEMENT STRATEGIES

2.1 Rule-Based Approaches

The first energy management formulation we considered was motivated by the FutureCar 1996 competition, and is documented in Baumann *et al.* (2000). In this paper, the authors present a rule-based control method for energy management of hybrid electric vehicles that forces vehicle to act at or near either peak point of efficiency or its lowest fuel use (Brake-Specific Fuel Consumption, BSFC) at all times. It turns out that the second option provides better fuel economy. The paper introduces the concept of Degree Of Hybridization (DOH), which provides a quantitative measure of the relative importance of electrical vs mechanical power in the hybrid powertrain. The DOH is defined by:

$$DOH = 1 - \frac{|P_{max,EM} - P_{max,ICE}|}{P_{max,EM} + P_{max,ICE}} \quad (7)$$

Graphically, Equation (7) is represented in Figure 1. The specific application described in the paper consists of an (ICE)-dominant hybrid vehicle with a DOH of 0.465.

In this study, an empirical methodology described as load-leveling is chosen to be the vehicle operation strategy. The idea behind “load-leveling an ICE dominated hybrid” is to move the actual ICE operating points as close as possible to some predetermined value

for every instant in time during the vehicle operation. For instance, if best fuel economy is sought, then vehicle operating points will be forced to take place at the lowest BSFC points that are compatible with the driver power request, and the resulting power difference will be provided by the electric machine. The possible power contribution of the electric machine to the overall drivetrain is limited by the state of charge of the battery pack, and by its torque and power limitations. Maintaining the battery SOC within a prescribed range is a second objective of the control policy, which results in the engine operating at higher power when appropriate to re-charge the battery and maintain the desired SOC range.

In order to implement the operation strategy, the authors propose Fuzzy Logic Control (FLC) as a means of implementing a set of heuristic rules in a systematic manner. Three steps are used to design the FLC:

- fuzzification, in which rules are expressed in the form of fuzzy logic statements;
- inference process;
- defuzzification, to arrive at a crisp output value.

The controller inputs are the driver torque request and the state of charge, and the outputs are the power split between ICE and the electric machine. The formal process generates a total of 847 rules that are implemented in the FLC. The controller so designed has a sufficiently general form that it can work with multiple control strategies. For example, the authors illustrate its use in a “peak efficiency” strategy and in a “minimum BSFC” strategy. The latter results in superior results.

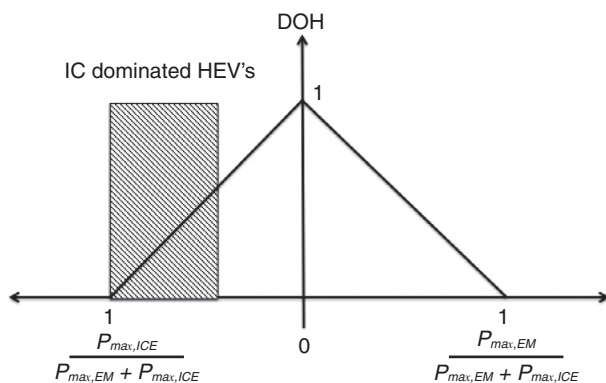

Figure 1
Degree of hybridization for HEV (Baumann *et al.*, 2000).

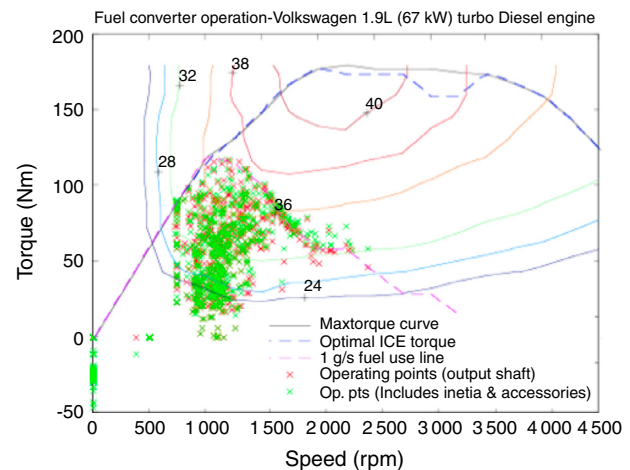

Figure 2
Efficiency map for HEV using the fuel use strategy (Baumann *et al.*, 2000).

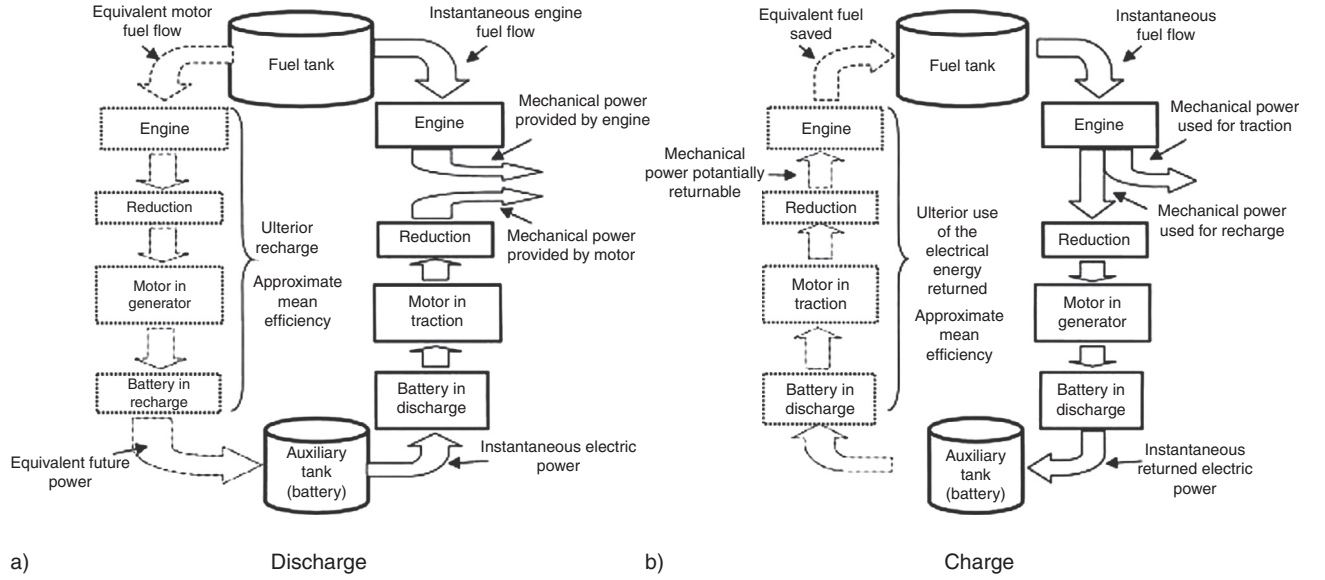

Figure 3

Energy path during charge and discharge in a parallel HEV Paganelli *et al.* (2000).

As one can see in Figure 2, the minimum BSFC control scheme forces the majority of operating points to be in the vicinity of the points of the best fuel economy. This early approach to the HEV energy management problem showed some initial success, and was implemented in simulation and in a prototype vehicle. The calibration complexity (847 rules!) and the heuristic nature of the strategy, with no explicit consideration of optimality, left much to be desired. In 1999, Gino Paganelli joined our group as a post-doctoral scholar, having completed his doctorate at Université de Valenciennes in France. His arrival revolutionized our thinking with regard to the HEV energy management problem.

2.2 Equivalent Consumption Minimization Strategy

The Equivalent Consumption Minimization Strategy (ECMS) was first introduced by Paganelli in 1999 (Paganelli, 1999; Paganelli *et al.*, 2001a,b, 2002) as a method to reduce the global optimization problem to an instantaneous minimization problem to be solved at each instant, without use of information regarding the future. This strategy is based on the concept that, in charge-sustaining HEV, the battery is used only as an energy buffer, and all the energy ultimately comes from fuel (Fig. 3). Thus, the battery can be seen as an auxiliary, reversible fuel tank which is never refilled using energy from outside the vehicle. In order to keep the

vehicle charge-sustaining, the electricity used during the battery discharge phase must be replenished later using the fuel from the engine (either directly or indirectly through a regenerative path). In both charge and discharge phase, a virtual fuel consumption can be associated with the use of electrical energy, and summed to the actual fuel consumption to obtain the instantaneous equivalent fuel consumption:

$$\dot{m}_{eqv}(t) = \dot{m}_f(t) + \dot{m}_{batt}(t) \quad (8)$$

$$= \dot{m}_f(t) + \frac{s}{Q_{lhv}} P_{batt}(t) \cdot (1 - p(x)) \quad (9)$$

where $\dot{m}_f(t)$ is the engine instantaneous fuel consumption, $\dot{m}_{batt}(t)$ is the virtual fuel consumption associated with the use of the battery, $P_{batt}(t)$ the battery power, and $p(x)$ is a correction function that takes into account the deviation of the current SOC, x , from the reference SOC, x_{ref} . The correction term $p(x)$ is shown in Figure 4. The factor s is called equivalence factor and is used to convert electrical power into equivalent fuel consumption; it plays an important role in the ECMS, as will be shown later.

Depending on the sign of $P_{batt}(t)$ (*i.e.*, on whether the battery is charged or discharged), the virtual fuel flow rate can be either positive or negative, therefore the equivalent fuel consumption can be higher or lower than the actual fuel consumption.

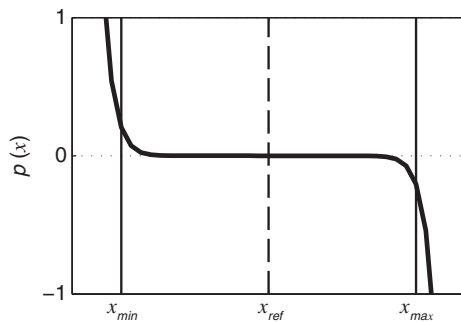

Figure 4

SOC correction term for ECMS, $p(x)$.

In the simplest implementation of ECMS, the equivalence factor is a constant, or rather a set of constants that represent the chain of efficiencies through which fuel is transformed into electrical power and vice-versa. In particular, there are at least two equivalence factors, one to apply during battery charge, and another during battery discharge. In each mode, the equivalence factor represents the average overall efficiency of the electric path, during a specific driving cycle. The equivalence factor can be interpreted intuitively as the future cost of the fuel that will be required to replenish the battery charge used at the present time. Thus, its value depends on the driving cycle.

The values of the equivalence factors affect the vehicle fuel consumption and the trend of the battery state of charge, which tends to be discharged if the equivalence factor is too low (charge-depleting behavior) or to be charged if it is too high (charge-increasing behavior). In order to obtain a charge-sustaining solution and minimize the total fuel consumption during a driving cycle, it is necessary to tune all the equivalence factors for the specific driving cycle. For example, it is possible to define a charge and a discharge equivalence factors (s_{chg} and s_{dis}), corresponding respectively to negative and positive values of battery power P_{batt} .

In a practical implementation of ECMS, the calibration process consists of pre-computing the optimal value of the instantaneous (equivalent) fuel consumption of each energy converter (ICE and Electric Machine, EM), so that, given a specific torque request the combination of ICE and EM torques selected is the one that results in the minimum instantaneous fuel consumption. Figures 5 and 6 show such pre-computed maps for the case of the FutureTruck 2000 hybrid-electric SUV (Paganelli *et al.*, 2001c). Figure 7 shows the possible ranges of ICE and EM torque contributions to the total requested torque at one particular engine speed, illustrating how the contributions would affect the state of charge of the battery. Figure 8 shows experimental

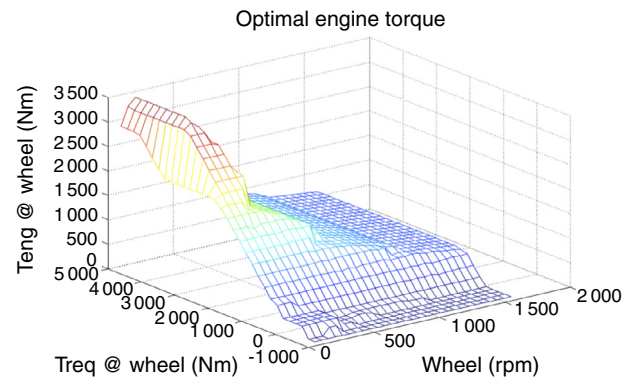

Figure 5

Optimal ICE torque resulting from calibration process (Paganelli *et al.*, 2001c).

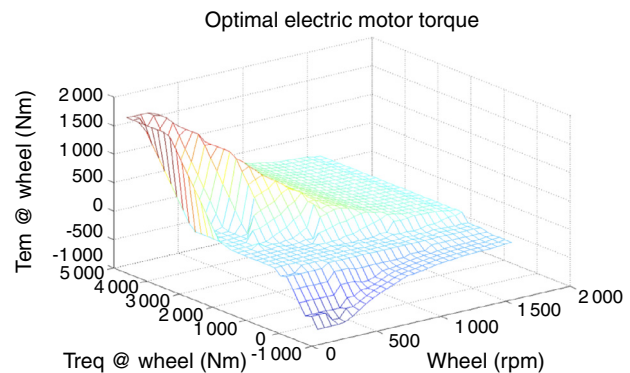

Figure 6

Optimal EM torque resulting from calibration process (Paganelli *et al.*, 2001c).

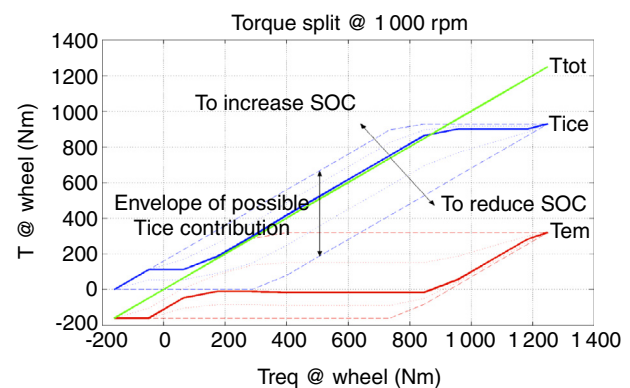

Figure 7

Effect of ICE and EM torques on SOC (Paganelli *et al.*, 2001c).

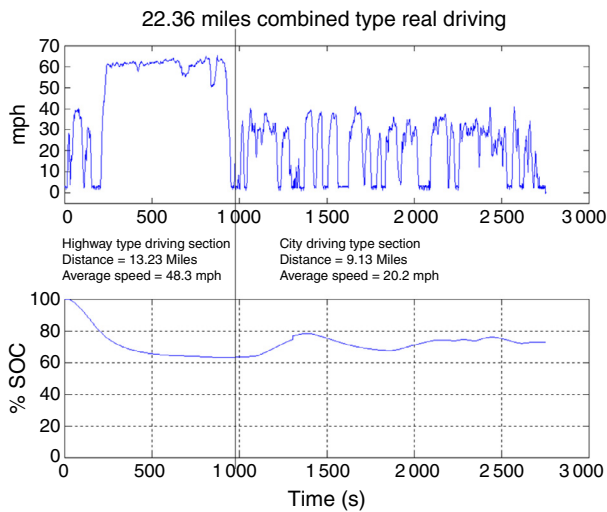

Figure 8
Actual driving profile and measured battery SOC from on-vehicle implementation of ECMS (Paganelli *et al.*, 2001c).

results for a hybrid SUV (*GM Suburban*), the first vehicle that saw the implementation of the ECMS strategy at the Ohio State University, in the summer of 2000.

2.3 Dynamic Programming and Optimal Control Methods

While ECMS provided a viable and practical solution to the energy management problem, the desire for a more formal optimization approach started surfacing. In Brahma *et al.* (2000) it was first proposed that the optimization problem of the instantaneous mechanical/electrical power split in parallel hybrid electric vehicles could be solved using Dynamic Programming (DP). ECMS is based on the premise that a local optimal solution can approach global optimality, which is addressed by means of DP. The price, though, one pays for the global optimum is that physical realizability is not possible, as it depends on knowing the precise vehicle driving cycle a priori. In Brahma *et al.* (2000), the authors proposed an approach that applies DP algorithm to the optimization process for the power split between both sources of energy, with realistic cost calculation for all considered paths for the IC engine, EM machines and battery efficiencies, and a penalty function formulation for the deviation of the ideal SOC to be sustained over the length of time considered. In this work, charge sustaining was a continuous modulation of the battery SOC within certain operational bounds. The overall integral charge sustaining constraint causes the instantaneous

power flows in the system to become sequentially coupled to each other. Thus, power flow values at one instance of operation have an effect on the allowable power flow values at a later time. This transforms the nature of the optimization problem by rendering it non-local in time which implies that a method such as dynamic programming is extremely appropriate for the solution of a problem of this nature. This approach was formalized by others, as explained in a later section, and has become a standard method for establishing the benchmark performance of energy management algorithms.

Formal approaches based on optimal control were also proposed in Wei (2004) and in Wei *et al.* (2007), which included applying Pontryagin's Minimum Principle (PMP) and Variable Structure Control (VSC). This work was expanded in Serrao *et al.* (2009), Serrao (2009), and is explained in Section 2.5.

2.4 Adaptive ECMS Methods – Early Results

As mentioned earlier, ECMS can generate the optimal energy management solution for a given cycle, provided that the strategy is properly tuned by choosing the appropriate value of equivalence factor. The equivalence factor plays a crucial role in the charge sustaining ECMS; it trades off chemical against electric power. If the equivalence factor is very large, then the ECMS tends to recharge the battery in almost all operating points. If the equivalence factor is very small, then the ECMS favors pure electric driving. Since perfect tuning is possible only with *a-priori* knowledge of the cycle, research efforts have been directed towards online adaptation of ECMS, in order to achieve quasi-optimal results even without *a-priori* tuning of the strategy.

Two categories of methods have been initially proposed at CAR to design A-ECMS. They are:

- adaptation based on driving cycle prediction (Musardo *et al.*, 2004a, 2005a, b);
- adaptation based on driving pattern recognition (Gu and Rizzoni, 2006; Gu, 2006).

Adaptation Based on Driving Cycle Prediction

The driving principle behind this class of methods is that when no information on future driving conditions is available, optimal fuel economy cannot be guaranteed. Thus, this family of algorithms aims at using any sort of future information to feed the ECMS control module with the more suitable value of equivalence factor.

Historically, this was the first adaptation approach. In fact, A-ECMS was first proposed in Musardo *et al.* (2004b) (and Musardo *et al.*, 2004a, 2005a,b), by the same group

of authors. In this series of papers, the term A-ECMS was coined and conceived as a real-time energy management strategy obtained adding to the ECMS framework an on-the-fly algorithm for the estimation of the equivalence factor according to the driving conditions. The main idea being a periodical refresh of the control parameter according to the current road load, based on prediction of driving conditions. The identification of the driving mission combined with past and predicted data are used to determine the optimal equivalence factor over the optimization segment, according to the scheme shown in Figure 9. The ECMS module is effectively augmented with a device able to relate the control parameters to the current velocity profile. The reference SOC is kept constant in this A-ECMS prediction scheme. In the same papers, the authors formally use Dynamic Programming as a benchmark to assess the performance of the adaptive ECMS. A comparison of the performance of ECMS and A-ECMS *versus* the DP

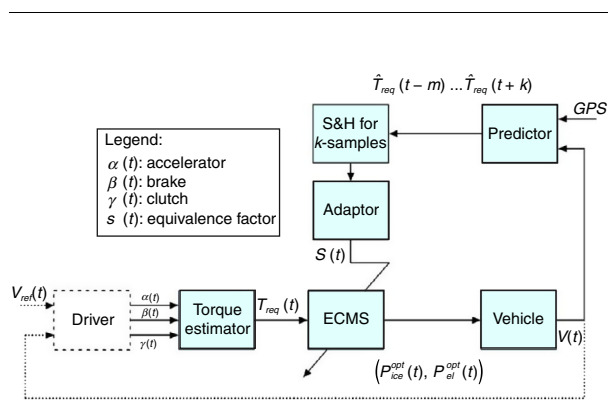

Figure 9

Control diagram of adaptive ECMS with online optimization (Musardo *et al.*, 2004a).

solution is summarized in Table 1. In this table, the “optimal ECMS solution” is one in which the optimal equivalence factor has been determined for each driving cycle using prior knowledge, whereas A-ECMS implements a real-time solution.

Much more recently, in Fu *et al.* (2011), the authors use a Model Predictive Control (MPC) based strategy and utilize the information attainable from Intelligent Transportation Systems (ITS) to establish a prediction based real-time controller structure. A constant reference SOC is considered and A-ECMS implemented as in Musardo *et al.* (2004a) is compared with a MPC type controller based on the prediction of future torque demand. The performances of the two controllers are very similar, indicating that A-ECMS with driving mission prediction is somehow equivalent to MPC. What emerges from the paper is also the importance of information provided by ITS and the impact of the accuracy of ITS information on HEV energy consumption.

Adaptation Based on Driving Pattern Recognition

In Gu and Rizzoni (2006), an approach for A-ECMS based on driving pattern recognition is presented. In this research, a driving pattern recognition method is used to obtain better estimation of the equivalence factor in different driving conditions. While the vehicle is running, a time window of past driving conditions is analyzed periodically and recognized as one of the representative driving patterns, according to the scheme of Figure 10.

A finite number of possible driving patterns is recognized, each corresponding to a pre-defined value of the equivalence factor (pre-computed from offline optimization). The battery SOC management is also maintained using a PI controller to keep the SOC around a nominal value (thus using feedback from SOC). Differently from

TABLE 1

Comparison of three energy management strategies over various driving cycles (Musardo *et al.*, 2005a)

Driving Cycle	Pure thermal	DP		ECMS optimal		A-ECMS	
	mpg	mpg	Improv.	mpg	Improv.	mpg	Improv.
FUDS	22.1	25.7	16.4%	25.7	16.3%	25.5	15.5%
FHDS	24.8	26.0	4.9%	25.8	4.1%	25.8	3.9%
ECE	20.8	24.5	18.2%	24.5	18.0%	24.5	17.9%
EUDC	23.3	24.8	6.3%	24.7	6.2%	24.7	6.1%
NEDC	22.2	24.5	10.7%	24.5	10.7%	24.4	10.1%
JPI1015	21.0	25.2	20.1%	25.1	19.8%	24.8	18.2%

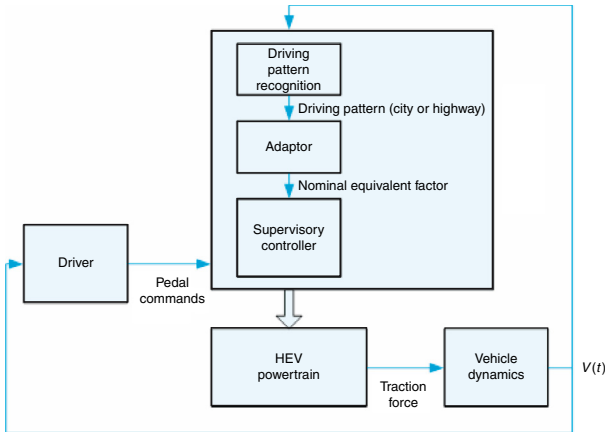

Figure 10
A-ECMS scheme based on pattern recognition (Gu and Rizzoni, 2006).

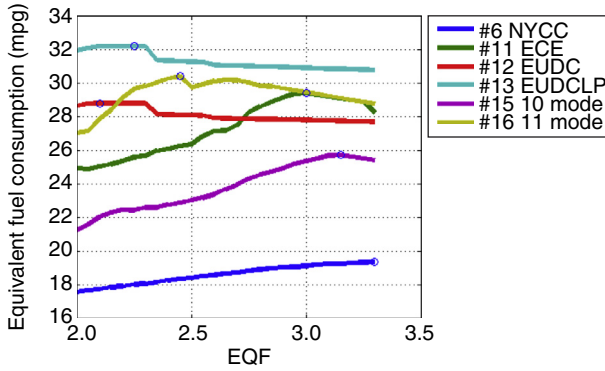

Figure 11
Fuel economy versus equivalence factor for different driving cycles (Gu and Rizzoni, 2006).

the methods seen before, such control algorithm does not require the knowledge of future driving cycles and has a low computational burden but higher memory requirement. Results obtained in this research show that the driving conditions can be successfully recognized and good performance can be achieved in various driving conditions while sustaining battery SOC within desired limits. Figure 11 shows the fuel consumption changes as a function of the equivalent factor (EQF) for different driving cycles. The optimal equivalence factors, which come out with the best fuel economy when ECMS is applied, are marked as a circle. It is obviously that, the optimal equivalence factors are widely spread and they significantly influence the fuel economy. In the paper,

the proposed algorithm readily distinguishes among three types of driving conditions, representing two variants of urban driving and highway driving.

2.5 Formalizing ECMS: Pontryagin's Minimum Principle

When the HEV energy management problem is cast into an optimal control problem, tools from the optimal control theory, such as analytical optimization methods, can be used. These methods use an analytical problem formulation to find the solution in closed, analytical form. Among these methods are PMP and the Hamilton-Jacobi-Bellmann equation Kirk (2004). It has been initially shown in Sciarretta and Guzzella (2007a) and further developed in Serrao *et al.* (2009) that methods based on PMP are equivalent, in that they generate the same solution, to the ECMS based approach.

The PMP provides necessary conditions for optimality (Geering, 2007). Every solution that satisfies the necessary conditions is called an extremal solution. If the optimal solution exists, then it is also extremal. The opposite, however, is not true: a solution may be extremal without being optimal. However, if the problem has a unique optimal solution, and the application of the minimum principle gives only one extremal solution, then this is the optimal solution.

In practical applications, the minimum principle can be used to find solution candidates by computing and minimizing the Hamiltonian function at each instant, which generates, by construction, extremal controls. If the Hamiltonian is a convex function of the control, then there is only one extremal solution, which is therefore optimal.

In the HEV energy management problem, the Hamiltonian is defined as:

$$H(x(t), u(t), \lambda(t), t) = \dot{m}_f(u(t), P_{req}(t)) - \lambda(t) \cdot f(x(t), u(t), t) \quad (10)$$

where $f(x(t), u(t), t)$ is given by Equation (2), and the control $u(t) = P_{batt}(t)$ is obtained at each instant as the value that minimizes Equation (10):

$$P_{batt}^*(t) = u^*(t) = \arg \min_{P_{batt}} H(x(t), u(t), \lambda(t), t) \quad (11)$$

The co-state variable $\lambda(t)$ appearing in Equation (10) is obtained as the solution of:

$$\dot{\lambda}(t) = -\lambda(t) \frac{\partial f(x(t), u(t), t)}{\partial x} \quad (12)$$

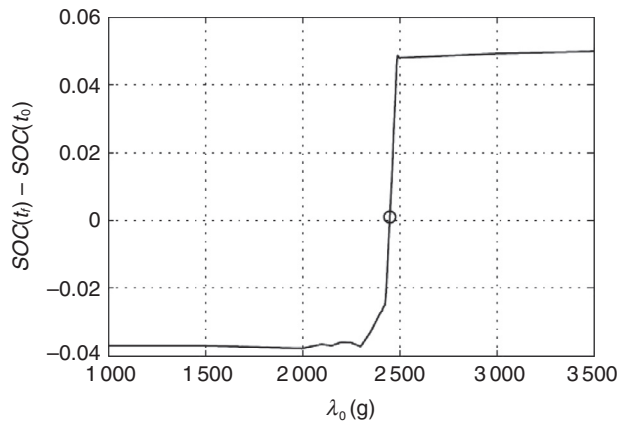

Figure 12

Effect of initial co-state value on SOC variation (Serrao *et al.*, 2011).

Equation (12), together with Equation (2), represents a system of two differential equations with two variables, $x(t)$ and $\lambda(t)$. The solution requires two boundary conditions. These are the initial and final value of the state: $x(t_0) = x_{ref}$ and $x(t_f) = x_{ref}$.

Despite being completely defined, this two-point boundary value problem can be solved numerically only using an iterative procedure, because one of the boundary conditions is defined at the final time. The procedure is known as shooting method and consists in replacing the two-point boundary value problem with a conventional initial-condition problem, starting from an initial guess for $\lambda(t_0)$. The solution of the problem is then obtained by integration in time of Equation (12) and Equation (2), replacing at each time the value of P_{batt} resulting from the minimization of Equation 11. If the final value of the state does not match the desired terminal condition $x^*(t_f) = x_{ref}$, the value of $\lambda(t_0)$ is adjusted iteratively until the terminal condition on the state is met. A bisection procedure can be used to obtain convergence in few iterations, making the minimum principle sensibly faster than DP. The solution is very sensitive to the initial co-state value, as shown in Figure 12.

The existence and uniqueness of the solution cannot be proved formally in the general case, but it is reasonable to assume that at least one optimal solution exists for the energy management problem, in the sense that there must necessarily be at least one sequence of controls giving the lowest possible fuel consumption. If the minimum principle generates only one extremal solution, that can be considered the optimal solution; if there is more than one extremal solution, they are all

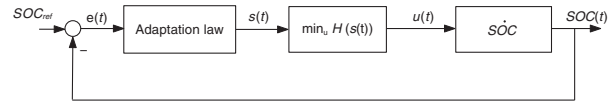

Figure 13

A-ECMS feedback scheme.

compared (*i.e.*, the total cost resulting from the application of each is evaluated) and the one yielding the lowest total cost is chosen.

2.6 Adaptive ECMS: Recent Results

The most recent and interesting approach developed at CAR to design A-ECMS is based on the feedback of the current SOC (Onori *et al.*, 2010; Onori and Serrao, 2011). This method tries to change dynamically the value of the equivalence factor in order to contrast the SOC variation (and thus maintain its value around the reference level). The following discrete time adaptation law was proposed:

$$s(x_k) = \frac{s(x_{k-1}) + s(x_{k-2})}{2} + k_p^d (x_{ref} - x_k) \quad (13)$$

where k is an integer number indicating the k -th fixed time interval of length T seconds, and $s(x_k)$ is the value of the equivalence factor in the interval $[(k-1)T, kT]$, x_k is the value of SOC at the beginning of said interval. Equation (13) is in the form of Auto-Regressive Moving-Average (ARMA) model, with two autoregressive terms and one moving average term. The key feature of (13) is that the adaptation takes place at regular intervals of duration T .

The correction of the equivalence factor s is achieved with a feedback on the system state, according to the scheme of Figure 13.

2.7 Rule-Based Approaches Based on Optimization Methods

While the DP is an invaluable tool to find the global optimal solution to the energy management problem, it cannot be implemented in a real time setting as it requires complete knowledge of the driving cycle in advance in addition to a high computational load. Nonetheless, the behavior obtained by the DP solution could in principle be mimicked and reproduced by means of a set of rules which are of easier implementation. Thus, inspired by Lin *et al.* (2003), Bianchi *et al.* (2010, 2011) and Biasini *et al.* (2012) we went through a re-thinking of a

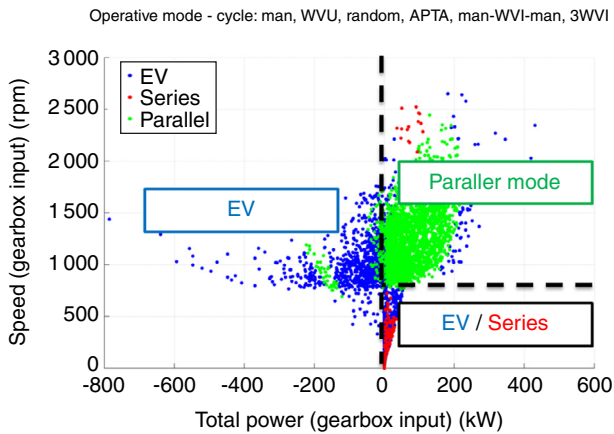

Figure 14

Hybrid powertrain mode of operation selection as a function of gearbox input torque and speed (Bianchi *et al.*, 2011).

rule-based approach in light of optimal control methods. The knowledge acquired from DP simulations over extensive driving conditions is captured and synthesized in the form of if-then-else rules which require very low computational load and relatively low calibration effort. These aspects have made the rule-based strategy the most appealing solution among all the others presented in this paper for product development process. The derivation of the rules from DP is a relatively fast process allowing to obtain results close to the optimal solution, and to reduce the number of calibration parameters. An example of data processing of DP solution is displayed in Figure 14, where, to understand the possible rule-based behavior of the supervisory control, the operating modes chosen by DP over all the analyzed driving cycles were plotted as function of the gearbox input torque and speed (a series-parallel hybrid medium duty truck was considered in this study). The plots shows that:

- at low speed and low torque, the powertrain works either in series or in pure electric (EV) mode;
- in the area limited by engine idle speed and positive gearbox torque only the parallel configuration is selected by the DP. The few points of series operation are only used to limit engine speed to its maximum;
- the third area includes all the points with a negative torque. In this case, the supervisory controller switches the engine off in order to save fuel since vehicle is decelerating.

In Figure 15, the comparison between the DP solution and RB strategy over the West Virginia Urban (WVU) suburban cycle shows how close the SOC profile from

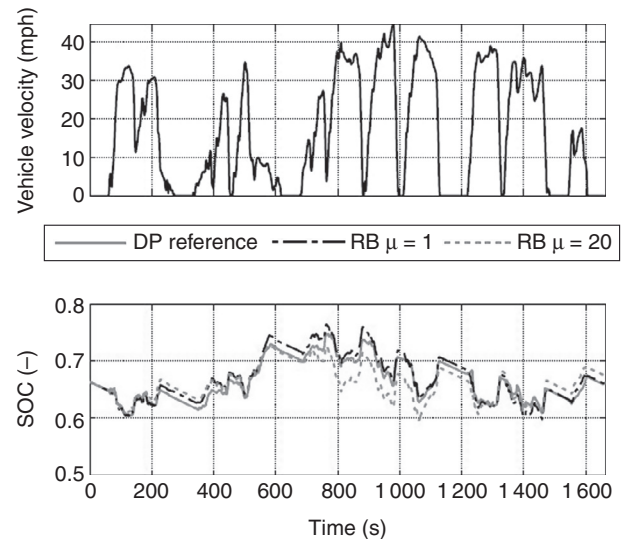

Figure 15

Comparison between RB and DP and effect of calibration parameter on the RB strategy over the WVU-suburban cycle.

RB is to the DP. The RB is shown for different values of the calibration parameter.

3 PHEV ENERGY MANAGEMENT

The problem of on-board energy management in PHEV offers different challenges from the HEV case. Compared to charge-sustaining HEV, PHEV are characterized by a larger energy storage system, as well as the ability of recharging the battery through direct connection to the energy grid. This provides the opportunity to deplete the battery during driving operations, further improving the vehicle fuel economy. Nevertheless, utilizing the battery with variable initial and final values of SOC and in a broader range poses complex challenges for the definition of a suitable energy management strategy that maximizes the overall energy efficiency, while complying with the limitations of vehicle components. In Tulpule *et al.* (2009a,b, 2010), the energy management problem in PHEV was initially investigated. In particular, two modes of operating a PHEV were considered: 1) EV mode control – the battery energy is used as quickly as possible followed by charge sustaining operation; and 2) Blended Mode control (BM) – the battery is discharged gradually throughout the trip. With respect to these two powertrain modes of operation different strategies (DP and ECMS) were compared and analyzed

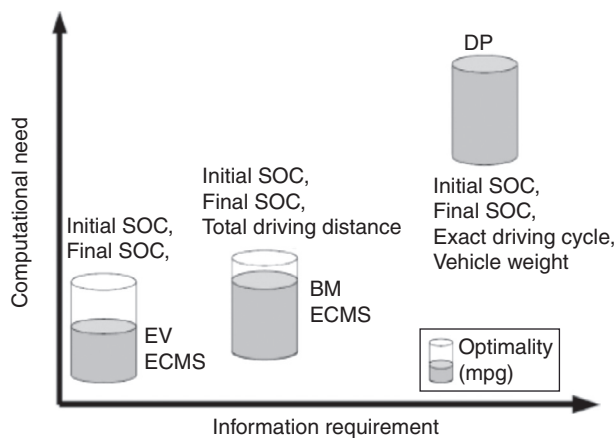

Figure 16

Comparison of the control strategies. DP: Dynamic Programming; BM ECMS: Blended Mode control using ECMS; EV ECMS: EV mode using ECMS and the ECMS and DP are compared in simulation (Tulpule *et al.*, 2009b).

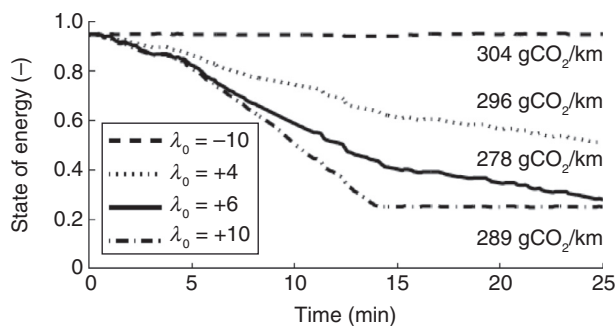

Figure 17

Evolution of the battery SOE as a function of the PMP control parameter.

in terms of amount of information needed to achieve optimality, as shown in the drawing in Figure 16.

In Stockar *et al.* (2011), a model-based control approach for PHEV energy management was presented based on the formulation of PMP implemented on a forward-based vehicle model simulator. In the optimization problem, a cost functional defined based on the cumulative CO₂ produced by the vehicle to account for both the fuel energy consumption and the use of the electrical energy from the grid was considered. In this study, it is shown that a near-optimal fuel economy and CO₂ emissions can be achieved with a minimal calibration effort, without the need of driving duty information. In Figure 17, it is shown how the CO₂ emission varies as a function of the PMP co-state λ_0 , which is one of the control calibration parameter in the PMP.

4 STRATEGIES COMPARISON

The energy management strategies reviewed in this paper can be classified into two main groups (Sampathnarayanan, 2013):

- non-causal or non-realizable strategies. They require complete *a priori* knowledge of the driving cycle and are not applicable in real conditions (*e.g.*, DP, PMP);
- causal or realizable strategies. They do not require a priori knowledge of the driving cycle and are developed with the primary objective of realizability and do not guarantee optimality (*e.g.*, Adaptive-PMP, rule-based, ECMS).

Although, the primary objective is to design and implement causal strategies that can be eventually tested on real vehicles, the importance of finding non-causal optimal solutions resides in that:

- they provide a benchmark solution (global optimum) any causal strategy can be compared against;
- properly modified they can be used to develop on-line strategies (Sciarretta and Guzzella, 2007; Serrao *et al.*, 2011).

Although rule-based energy management strategies are relatively easy to develop and implement in a real vehicle, a significant amount of calibration effort is required to guarantee performances within a satisfactory range for any driving cycle. Moreover, rules are not necessarily scalable to different powertrain architectures and different component sizes.

Local optimization methods, such as ECMS and PMP have gained popularity over DP as methods to find the global optimum. These methods are used to find the optimum by performing an offline optimization when the drive cycle is known (using a forward-looking vehicle simulator). Moreover, they can also be employed to design adaptive optimal strategies (AECMS) to achieve near optimal performances when the driving cycle is unknown.

The foundation laid in this paper presents many opportunities to extend this work to include various other objectives in the optimal control cost function. For example, considerations of engine exhaust emissions, of battery aging, and of drivability in the cost function give rise to interesting problems and are the subject of current research. A further extension of this work involves the use of geographical and traffic information and of navigation systems to provide a more accurate prediction of the vehicle trajectory, so as to be able to compute adaptive solutions using model predictive control and other methods. The use of cloud computing as a means of implementing more ambitious optimization algorithms that would otherwise not be

implementable in an on-board processor is also a topic of current research. The work presented in this paper offers a solid foundation for the study of these problems.

ACKNOWLEDGMENTS

The authors gratefully acknowledge the support of the United States Department of Energy through its GATE program, The United States Army TARDEC, Cummins, Inc., the OSU CAR Industrial Consortium, the OSU SMART@CAR Consortium, and numerous industry partners in making this research possible.

REFERENCES

- Ambuhl D., Guzzella L. (2009) Predictive reference signal generator for hybrid electric vehicles, *IEEE Transactions on Vehicular Technology* **58**, 9, 4730-4740. doi:10.1109/TVT.2009.2027709.
- Anatone M., Cipollone R., Sciarretta A. (2005) Control-oriented modeling and fuel optimal control of a series hybrid bus, *SAE paper* 2005-01-1163.
- Baumann B., Rizzoni G., Washington G. (2000) Mechatronic design and control of hybrid electric vehicles, *IEEE/ASME Transactions on Mechatronics*.
- Bianchi D., Rolando L., Serrao L., Onori S., Rizzoni G., Al-Khayat N., Hsieh T., Kang P. (2010) A rule-based strategy for a series/parallel hybrid electric vehicle: an approach based on dynamic programming, *ASME Dynamic Systems and Control Conference*, Cambridge, MA.
- Bianchi D., Rolando L., Serrao L., Onori S., Rizzoni G., Al-Khayat N., Hsieh T., Kang P. (2011) Layered control strategies for hybrid electric vehicles based on optimal control, *International Journal of Electric and Hybrid Vehicles* **3**, 191-217.
- Biasini R., Onori S., Rizzoni G. (2012) A rule based energy management strategy for hybrid medium duty truck, *International Journal of Powertrains*, forth coming.
- Brahma A., Guezennec Y., Rizzoni G. (2000) Dynamic optimization of mechanical/electrical power ow in parallel hybrid electric vehicles, *AVEC 2000, 5th International Symposium on Advanced Vehicle Control*, Ann Arbor, MI.
- Chasse A., Hafidi G., Poignant-Gros P., Sciarretta A. (2009) Online optimal control of a parallel hybrid with costate adaptation, *Proceedings of the 2009 Conference on Decision and Control (CDC09)*.
- Cipollone R., Sciarretta A. (2006) Analysis of the Potential Performance of a Combined Hybrid Vehicle with Optimal Supervisory Control, *Proceedings of the 2006 IEEE International Conference on Control Applications*, 2802-2807.
- Fu L., Ozguner U., Tulpule P., Marano V. (2011) Real-time energy management and sensitivity study for hybrid electric vehicles, *American Control Conference*.
- Geering H.P. (2007) *Optimal Control with Engineering Applications*, Springer, Berlin Heidelberg.
- Gu B. (2006) Supervisory Control Strategy Development for a Hybrid Electric Vehicle, *Master Thesis*, The Ohio State University.
- Gu B., Rizzoni G. (2006) An adaptive algorithm for hybrid electric vehicle energy management based on driving pattern recognition, *Proceedings of the ASME International Mechanical Engineering Congress and Exposition*.
- Guzzella L., Sciarretta A. (2007) *Vehicle Propulsion Systems: Introduction to Modeling and Optimization*, Springer.
- Kessels J. (2007) Energy Management for Automotive Power Nets, *PhD Thesis*, Technical University of Eindhoven.
- Kessels J., Koot M., van den Bosch P. (2006) Optimal adaptive solution to powersplit problem in vehicles with integrated starter/generator, *Proceedings of the 2006 IEEE Vehicle Power and Propulsion Conference*.
- Kessels J., Koot M., van den Bosch P., Kok D. (2008) Online energy management for hybrid electric vehicles, *IEEE Transactions on Vehicular Technology* **57**, 6, 3428-3440.
- Kirk D.E. (2004) *Optimal Control Theory: An Introduction*, Dover Publications.
- Lin C., Filipi Z., Wang Y., Louca L., Peng H., Assanis D., Stein J. (2001) Integrated, feed-forward hybrid electric vehicle simulation in simulink and its use for power management studies, *SAE Paper* 2001-01-1334.
- Lin C., Kim M., Peng H., Grizzle J. (2006) System level model and stochastic optimal control for a pem fuel cell hybrid vehicle, *Journal of Dynamic Systems, Measurement, and Control* **128**, 878.
- Lin C., Peng H., Grizzle J., Kang J. (2003) Power management strategy for a parallel hybrid electric truck, *IEEE Transactions on Control Systems Technology* **11**, 6, 839-849.
- Liu J., Peng H. (2008) Automated modelling of power-split hybrid vehicles, *Proceedings of the 17th IFAC World Congress*.
- Musardo C., Staccia B., Bittanti S., Guezennec Y., Guzzella L., Rizzoni G. (2004a) An adaptive algorithm for hybrid electric vehicles energy management, *FISITA 2004 World Automotive Congress*, Barcelona, Spain.
- Musardo C., Staccia B., Bittanti S., Guezennec Y., Guzzella L., Rizzoni G. (2004b) Predictive control for hybrid electric vehicles energy management, *FISITA 2004 World Automotive Congress*, Barcelona, Spain.
- Musardo C., Rizzoni G., Guezennec Y., Staccia B. (2005a) A-ECMS: An adaptive algorithm for hybrid electric vehicle energy management, *European Journal of Control* **11**, 4-5, 509-524.
- Musardo C., Staccia B., Midlam-Mohler S., Guezennec Y., Rizzoni G. (2005b) Supervisory control for nox reduction of an HEV with a mixed-mode HCCI/CIDI engine, *Proceedings of the 2005 American Control Conference*.
- Onori S., Serrao L. (2011) On Adaptive-ECMS strategies for hybrid electric vehicles, *Les Rencontres Scientifiques d'IFP Energies nouvelles - RHEVE 2011*.
- Onori S., Serrao L., Rizzoni G. (2010) Adaptive Equivalent Consumption Minimization Strategy for HEVs, *IASME Dynamic Systems and Control Conference*.
- Paganelli G., Guerra T., Delprat S., Santin J., Delhom M., Combes E. (2000) Simulation and assessment of power control strategies for a parallel hybrid car, *Proceedings of the Institution of Mechanical Engineers, Part D: Journal of Automobile Engineering* **214**, 7, 705-717.
- Paganelli G., Brahma A., Rizzoni G., Guezennec Y.G. (2001a) Control development for a hybrid-electric sport-utility vehicle: Strategy, implementation and field test results, *American Control Conference*.

- Paganelli G., Ercole G., Brahma A., Guezennec Y., Rizzoni G. (2001b) General supervisory control policy for the energy optimization of charge-sustaining hybrid electric vehicles, *JSAE* **22**, 511-518.
- Paganelli G., Guezennec Y., Rizzoni G. (2002) Optimizing control strategy for hybrid fuel cell vehicle, *SAE Transactions, Journal of Engines*.
- Paganelli G., Tateno M., Brahma A., Rizzoni G., Guezennec Y. (2001c) Control development for a hybrid-electric sport-utility vehicle: strategy, implementation and field test results. **2**, 5064-5064.
- Paganelli G. (1999) Conception et commande d'une chaîne de traction pour véhicule hybride parallèle électrique et électrique, *PhD Thesis*, Université de Valenciennes, Valenciennes, France
- Rodatz P., Paganelli G., Sciarretta A., Guzzella L. (2005) Optimal power management of an experimental fuel cell-supercapacitor powered hybrid vehicle, *Control Engineering Practice* **13**, 41-53.
- Sampathnarayanan B. (2013) Analysis and Design of Stable and Optimal Energy Management Strategies for Hybrid Electric Vehicles, *PhD Thesis*, The Ohio State University.
- Sciarretta A., Guzzella L. (2007) Control of hybrid electric vehicles, *IEEE Control Systems* **27**, 2, 60-70.
- Sciarretta A., Guzzella L., Onder C. (2003) On the power split control of parallel hybrid vehicles: from global optimization towards real-time control, *Automatisierungstechnik* **51**, 5, 195-203.
- Sciarretta A., Back M., Guzzella L. (2004) Optimal control of parallel hybrid electric vehicles, *IEEE Transactions on Control Systems Technology* **12**, 3, 352-363.
- Serrao L. (2009) A comparative analysis of energy management strategies for hybrid electric vehicles, *PhD Thesis*, OSU.
- Serrao L., Onori S., Rizzoni G. (2009) ECMS as a Realization of Pontryagin's Minimum Principle for HEV Control, *Proceedings of the 2009 American Control Conference*.
- Serrao L., Onori S., Rizzoni G. (2011) A comparative analysis of energy management strategies for hybrid electric vehicles, *ASME Transactions, Journal of Dynamic Systems, Measurement and Control* **133**, 03-12.
- Stockar S., Marano V., Canova M., Rizzoni G., Guzzella L. (2011) Energy-optimal control of plugging hybrid electric vehicles for real-world driving cycles, *IEEE Transactions on Vehicular Technology* **60**, 2940-2962.
- Sundström O., Ambühl D., Guzzella L. (2010) On implementation of dynamic programming for optimal control problems with final state constraints, *Oil and Gas Science and Technology – Rev IFP* **65**, 91-102.
- Sundström O., Guzzella L. (2009) A generic dynamic programming matlab function, *Proceedings of the 18th IEEE International Conference on Control Applications*, 1623-1630.
- Sundström O., Guzzella L., Soltic P. (2008) Optimal hybridization in two parallel hybrid electric vehicles using dynamic programming, *Proceedings of the 17th IFAC World Congress*.
- Tate E., Grizzle J., Peng H. (2007) SP-SDP for fuel consumption and tailpipe emissions minimization in an EVT hybrid, *IEEE Transactions on Control Systems Technology*.
- Tulpule P., Marano V., Rizzoni G. (2009a) Energy management for plug-in hybrid electric vehicles using equivalent consumption minimisation strategy, *International Journal of Electric and Hybrid Vehicles* **2**, 329-350.
- Tulpule P., Stockar S., Marano V., Onori S., Rizzoni G. (2009b) Comparative studies of different control strategies for plug-in hybrid electric vehicles, *International 9th Conference on Engines and Vehicles*, Capri, Naples, Italy.
- Tulpule P., Marano V., Rizzoni G. (2010) Energy management for plug-in hybrid electric vehicles using equivalent consumption minimisation strategy, *Electric and Hybrid Vehicles Int. J.* **2**, 4, 329-350.
- Wei X., Guzzella L., Utkin V., Rizzoni G. (2007) Model-based fuel optimal control of hybrid electric vehicle using variable structure control systems, *Journal of Dynamic Systems, Measurement, and Control* **129**, 13.
- Wei X. (2004) Optimal control of hybrid electric vehicles. *PhD Thesis*, The Ohio State University.
- Wu B., Lin C., Filipi Z., Peng H., Assanis D. (2004) Optimal power management for a hydraulic hybrid delivery truck, *Vehicle System Dynamics* **42**, 1, 23-40.

Manuscript accepted in January 2014

Published online in July 2014

Copyright © 2014 IFP Energies nouvelles

Permission to make digital or hard copies of part or all of this work for personal or classroom use is granted without fee provided that copies are not made or distributed for profit or commercial advantage and that copies bear this notice and the full citation on the first page. Copyrights for components of this work owned by others than IFP Energies nouvelles must be honored. Abstracting with credit is permitted. To copy otherwise, to republish, to post on servers, or to redistribute to lists, requires prior specific permission and/or a fee: request permission from Information Mission, IFP Energies nouvelles, revueogst@ifpen.fr.